

Award Number: DE-FE0029474

## **Integrated CCS for Kansas (ICKan)**

DUNS NUMBER: 076248616

Research Performance Progress Report (Quarterly)

*Submitted to:*

The Department of Energy  
National Energy Technology Laboratory

*Recipient:*

University of Kansas Center for Research &  
Kansas Geological Survey  
1930 Constant Avenue  
Lawrence, KS 66047

*Submitted by:*

Joint Principal Investigators:

Tandis Bidgoli  
785-864-3315  
[tbidgoli@kgs.ku.edu](mailto:tbidgoli@kgs.ku.edu)

& Martin Dubois  
785-218-3012  
[mdubois@ihr-llc.com](mailto:mdubois@ihr-llc.com)

Date of Report: 07-31-17

**Project Period: March 15, 2017 to September 15, 2018**

**Period Covered by the Report: March 1, 2017 to June 30, 2017**

Signature of submitting official:

A handwritten signature in black ink, appearing to read 'Tandis Bidgoli', with a long horizontal line extending to the right.

**Tandis S. Bidgoli, Assistant Scientist**

# INTRODUCTION

## A. OBJECTIVES

This *Phase I- Integrated CCS Pre-Feasibility Study* activity under CarbonSAFE will evaluate and develop a plan and strategy to address the challenges and opportunities for commercial-scale Carbon Capture and Storage (CCS) in Kansas, *ICKan (Integrated CCS for Kansas)*. The objectives of *ICKan* include identifying and addressing the major technical and nontechnical challenges of implementing CO<sub>2</sub> capture and transport and establishing secure geologic storage for CO<sub>2</sub> in Kansas. The study will examine three of Kansas' largest CO<sub>2</sub> point sources and corresponding storage sites, each with an estimated 50+ million tons capacity (of saline aquifer storage), and a local transportation network to connect with nearby geologic storage. The project will also provide high level technical sub-basinal evaluation, building on previous characterization of the regional stacked storage complex.

## B. SCOPE OF WORK

ACCS Coordination Team will examine three of Kansas' largest CO<sub>2</sub> point sources and corresponding storage sites, each with an estimated 50+ million tons capacity, and a local transportation network to connect with nearby geologic storage. *ICKan* will evaluate and develop a plan and strategy to address the challenges and opportunities for commercial-scale CCS in Kansas. The *Team* will identify and address the major technical and nontechnical challenges of implementing capture, transportation, and secure geologic storage of CO<sub>2</sub> in Kansas.

The *ICKan* and CCS Coordination Team will generate information that will allow DOE to make a determination of the proposed storage complex's level of readiness for additional development under Phase II, by establishing and addressing the key challenges in commercial scale capture, transportation, and storage in this investigation.

## C. TASKS TO BE PERFORMED

### **Task 1.0 – Project Management and Planning Integrated CCS for Kansas (ICKan)**

This Task includes the necessary activities to ensure coordination and planning of the project with DOE/NETL and other project participants. These activities include, but are not limited to, the monitoring and controlling of project scope, cost, schedule, and risk, and the submission and approval of required National Environmental Policy Act (NEPA) documentation

This Task includes all work elements required to maintain and revise the Project Management Plan, and to manage and report on activities in accordance with the plan.

Subtask 1.1 - Fulfill requirements for National Environmental Policy Act (NEPA) documentation  
Phase I shall not involve work in the field, thus the activities shall have no adverse impact on the environment. Potential future activities that could have negative environmental impact in subsequent project phases will be documented in the Phase I reports.

Subtask 1.2 - Conduct a kick-off meeting to set expectations  
The PIs shall layout expectations for adherence to scope, schedule, budget, risk management, and overall project plan in an "all-hands" meeting within the first four weeks of project initiation. The PIs shall provide protocols and reporting mechanisms for notice of modifications.

Subtask 1.3 - Conduct regularly scheduled meetings and update tracking

The team shall hold regularly scheduled monthly meetings including all personnel and subcontractors via conference calls or online videoconferences. The PIs shall update scope, tasks, schedule, costs, risks, and distribute to the DOE and the project team. Accountability shall be encouraged by the monthly review sessions. The PIs shall hold full CCS team meetings (including CO<sub>2</sub> sources and field operators) quarterly.

#### Subtask 1.4 - Monitor and control project scope

PIs shall evaluate and analyze monthly reports from all team section leads ensuring compliance with the requirements of DOE.

#### Subtask 1.5- Monitor and control project schedule

PIs shall closely monitor adherence to the project schedule, facilitated by monthly project team meetings. Schedule tracking and modifications shall be provided to the team on a monthly basis. PI will monitor resources to ensure timely completion of tasks.

#### Subtask 1.6 - Monitor and control project risk

Project risks and mitigation protocol shall be discussed with the team at the beginning of the project to help limit risks being realized and help recognize patterns that could signal increased risk.

Subtask 1.7 - Finalize the DMP. The DMP and its components shall be finalized by the PI. Information acquired, during the project, will be shared via the NETL-EDX data portal including basic and derived information used to describe and interpret the data and supplementary information to a published document. Information will be protected in accordance with the usage agreements and licenses of those who contribute the data.

#### Subtask 1.8 - Revisions to the PMP after submission

The PMP shall be updated as needed, including: 1) details from the negotiation process through consultation with the Federal Project Officer, 2) revisions in schedule, 3) modifications in the budget, 4) changes in scope and tasks, 5) additions or changes in personnel, and 5) other material changes in the project.

#### Subtask 1.9 - Develop an integrated strategy/business plan for commercial scale CCS

The PIs shall set goals and timelines in early meetings and the team shall develop and build on strategy that will be documented in a business plan.

### **Task 2.0 – Establish a Carbon Capture and Storage (CCS) Coordination Team**

The PIs shall develop a multidisciplinary team capable of addressing technical and non-technical challenges specific to commercial-scale deployment of the CO<sub>2</sub> storage project. The Phase I team will 1) determine if any additional expertise and manpower required for Phase II, 2) recommend individuals, groups or institutions to fill any additional needs that are identified, and 3) assist in the recruitment and gaining formal commitments by key individuals or institutions for Phase II.

#### Subtask 2.1 - Identify additional CCS team members

Identify additional team members required to evaluate; 1) geologic storage complex, 2) large-scale anthropogenic sources and approaches to capturing CO<sub>2</sub>, 3) transportation/delivery systems from source to the geologic complexes and injection into the storage reservoir, 4) costs, economics and financial requirements, 5) legal and political challenges, and 6) public outreach for the Phase II effort. Future needs will also be evaluated and additional team members will be selected if there are additional gaps in technical or non-technical areas that would be advisable to fill.

#### Subtask 2.2 - Identify additional stakeholders that should be added to the CCS team

The team will identify possible additional stakeholders that could include environmental groups, business

groups, state legislators, state organizations (commerce), rate-payer organizations, land use and land owner groups.

#### Subtask 2.3 - Recruit and gain commitment of additional CCS team members identified

A comprehensive review of the gap analyses and develop recommendations of additional individuals, groups or institutions which should be filled before proceeding to Phase II. The CCS team shall identify primary and secondary choices, recruit, and gain commitments for possible participation in Phase II.

#### Subtask 2.4 - Conduct a formal meeting that includes the Phase I team and committed Phase II team members

A one-day working meeting will be conducted to 1) review Phase I preliminary results, 2) present draft plans for Phase II, and 3) gather input from recruited potential Phase II members. The meeting shall be held at the KGS or a mutually agreed upon alternate site with an option to participate by videoconferencing.

### **Task 3.0 – Develop a plan to address challenges of a commercial-scale CCS Project**

This application presents three candidate sources and identifies three possible geologic complexes suitable for storage. Phase I work shall determine which are most feasible, and shall identify and develop a preliminary plan to address the unique challenges of each source/geologic complex that may be feasible for commercial-scale CCS (50+ million tonnes captured and stored in a saline aquifer). Reliable and tested approaches, such as Road mapping and related activities (Phaal, et al., 2004, Gonzales-Salavar, et al., 2016; IEA, 2013; DOE, 2003) shall be used to identify, select, and establish alternative technical and non-technical options based on sound, transparent analyses including monitoring for adjustment as the assessment matures.

#### Subtask 3.1 - Identify challenges and develop a plan to address challenges for CO<sub>2</sub> capture from anthropogenic sources

A plan will be developed that addresses CO<sub>2</sub> capture including use of plant configuration, current and anticipated operating conditions, product distribution (e.g. electrical power grid), and regulatory uncertainty.

#### Subtask 3.2 - Identify challenges and develop a plan to address challenges for CO<sub>2</sub> transportation and injection

A plan will be developed that describes challenges specific to Kansas to deliver CO<sub>2</sub> to the injection well(s) including addressing regulations, right of way, pipeline configuration, maintenance, safety, and deliverability.

#### Subtask 3.3 - Identify challenges and develop a plan to address challenges for CO<sub>2</sub> storage in geologic complexes

The KGS shall evaluate candidate geological complexes for technical risks (capacity, seal, faults, seismicity, pressure, existing wellbores), economics (location/distance, injectivity, availability), and legal (pore space rights, liability) and document the results in a plan.

### **Task 4.0 – Perform a high level technical sub-basinal evaluation using NRAP and related DOE tools**

Three candidate sources and two possible storage complexes were identified. Phase I work shall determine which are most feasible, and will identify and develop a plan to address the unique challenges of each storage complex that may be feasible for commercial-scale CCS (50+ Mt captured and stored in a saline aquifer). Each location will be evaluated using NRAP models and the results shall be submitted to DOE.

#### Subtask 4.1 - Review storage capacity of geologic complexes identified in this proposal and consider alternatives

Three possible sites in two complexes are in various stages of analysis and each appears to meet the 50+Mt storage requirement. They shall be further evaluated and a survey of other potential geologic structures will undergo a rigorous site screening and selection process to determine suitability.

**Subtask 4.2 - Conduct high-level technical analysis of suitable geologic complexes using NRAP- IAM-CS and other tools for integrated assessment**

The KGS shall evaluate candidate storage complexes in terms of capacity, seal, faults, seismicity, pressure, existing wellbores, and injectivity.

**Subtask 4.3 - Compare results using NRAP with methods used in prior DOE contracts including regional and sub-basin CO<sub>2</sub> storage**

The CCS team shall use the results of the NRAP models obtained in this study with the regional simulation of CO<sub>2</sub> storage in southern Kansas to provide an assessment of risk to this greater area and compare with findings of project DE-FE0002056, including Pleasant Prairie Field and other potentially prospective storage sites (e.g., Eubank, Cutter, and Shuck fields).

**Subtask 4.4 - Develop an implementation plan and strategy for commercial-scale, safe and effective CO<sub>2</sub> storage**

A technology roadmap or similar methodology shall be used to convey a detailed realistic implementation plan and strategy that shall utilize the experience gained by the KGS in developing a US EPA Class VI permit. The result shall be based on a sound analysis that meets the goals of stakeholders, defines effective action, and is adaptable and open for review and updates as conditions change, e.g., new technology breakthroughs, incentivizing, and market conditions (McDowall, 2012).

**Task 5.0 – Perform a high level technical CO<sub>2</sub> source assessment for capture**

An assessment of the capture technologies best suited for efficiency, addressing the concerns of the electric utilities and their operating requirements and economic needs will be performed.

**Subtask 5.1 - Review current technologies and CO<sub>2</sub> sources of team members and nearby sources using NATCARB, Global CO<sub>2</sub> Storage Portal, and KDM**

The CCS team shall develop an organized electronic clearinghouse of vital information pertaining to the project, ranked by suitability, historical usage records, adaptability, scaling, and demonstration of success, and operations and maintenance requirements.

**Subtask 5.2 - Determine novel technologies or approaches for CO<sub>2</sub> capture**

CO<sub>2</sub> sources shall carefully be evaluated for suitability with new capture technologies. The evaluation will utilize private research including that sponsored by DOE and results of international efforts and projects such as DOE's Carbon Capture Simulation Initiative (CCSI) to determine the suitability and rationale for making decisions to pursue or table the technology.

**Subtask 5.3 - Develop an implementation plan and strategy for cost effective and reliable carbon capture**

An optimal CCS plan and strategy that best represents the holistic operating environment and requirements of the CO<sub>2</sub> sources will be developed. The team shall develop a means to ensure a mechanism to update and adapt to new disruptive technologies and possibly accommodate them in the design document.

**Task 6.0 – Perform a high level technical assessment for CO<sub>2</sub> transportation**

The CCS team shall consider best practices in pipeline design to ensure safety, security, and compliance with regulations in force in Kansas and other states where the pipeline may extend.

**Subtask 6.1 - Review current technologies for CO<sub>2</sub> transportation**

The CCS team shall address the challenges in pipeline transportation and shall catalog and classify the

technologies best suited for use in Kansas.

Subtask 6.2 - Determine novel technologies or approaches for CO<sub>2</sub> transportation

The CCS team shall review the challenges and solutions conveyed by current research and development and using a SWOT analysis determine the suitability and rationale for making a decision to pursue or table transportation technologies.

Subtask 6.3 - Develop a plan for cost-efficient and secure transportation infrastructure

The CCS team shall develop an optimal plan and strategy for a CO<sub>2</sub> distribution system that aligns with the needs of the proposed CO<sub>2</sub> sources and the storage complex put forth by the team.

### **Task 7.0 – Technology Transfer**

Subtask 7.1 - Maintain website on KGS server to facilitate effective and efficient interaction of the team

The KGS shall create and maintain a web site available to both the members of the CCS team and the public. A non-secured site portion of the site shall be dedicated to apprising the public on the status of the on-going project as well as publishing the acquired data. The format of the public site shall be directed toward both technical and non-technical audiences. The public site will contain all non-confidential reports, public presentations, and papers. All data developed by the project or interpretation of existing data, performed by the project, shall be uploaded to EDX ([edx.netl.doe.gov](http://edx.netl.doe.gov)).

Subtask 7.2 - Public presentations

Progress and information gained from the study shall be conveyed to the public when deemed appropriate to enable an understanding of issues, concerns, and solutions for Integrated CCS in Kansas, *ICKan*. A focused dialog with interested stakeholders shall be sought through informational meetings and workshops that correspond with formal reporting to DOE including intermediate results and the final report. Prior to the final report being released, the CCS team shall invite key stakeholders and interest groups to participate in addressing the general topics of CCS and to comment on the plan and strategy through a conference and workshop in order to build public support for taking the next steps in *ICKan*.

Subtask 7.3 - Publications

The CCS team shall publish methodologies, findings, and recommendations.

## **D. DELIVERABLES**

Reports will be submitted in accordance with the attached “Federal Assistance Reporting Checklist” and the instructions accompanying the checklist.

In addition to the reports specified in the "Federal Assistance Reporting Checklist", the Recipient will provide the following to the DOE Project Officer.

### **Data Submitted to NETL-EDX**

Data generated as a result of this project shall be submitted to NETL for inclusion in the NETL Energy Data eXchange (EDX), <https://edx.netl.doe.gov/>. The Recipient will work with the DOE Project Officer to assess if there is data that should be submitted to EDX and identify the proper file formats prior to submission. All final data generated by this project shall be submitted to EDX including, but not limited to: 1) datasets and files, 2) metadata, 3) software/tools, and 4) articles developed as part of this project.

Other key deliverable include:

- Task 1.0–Project Management Plan
- Task 1.10 – Technical report on *Integrated Strategy For Commercial-Scale CCS Project*
- Task 2.0 – Commitment letters from fully formed *CCS Coordination Team*
- Task 3.0 – Technical report on *Plan to Address Challenges of the Commercial-Scale CCS Project*
- Task 4.0 – Technical report on *High-Level Sub-Basinal Evaluations*
- Task 5.0 – Technical report on *High-Level CO<sub>2</sub> Source Assessment for Capture*
- Task 6.0 – Technical report on *High-Level Assessment for CO<sub>2</sub> Transportation*
- Initial Business Plan that describes the selected source, capture technology, transportation route, and injection site(s), in a saline aquifer, with anticipated surface and subsurface infrastructure requirements. Additionally, a data gap analysis should be performed and include a discussion on the missing data and how the identified data gaps will be filled. There should be a discussion on non-technical issues such as outreach, political aspects of the project, legal requirements such as pore space ownership, permitting requirements, and the ownership of the CO<sub>2</sub>/liability throughout the process of capturing, transportation and injection. An economic analysis should be performed that includes anticipated costs for filling in data gaps, anticipated capital expenditures, construction costs, and future system operational expenditures for the proposed CCS system. There should be a list of anticipated sources of funding and strategies to pay for the installation and the operation of the CCS system. The business plan should also have discussions on how the costs of oil will affect the financing of the project and at what price point will it be economically feasible.

## **E. BRIEFINGS/TECHNICAL PRESENTATIONS**

The Recipient shall prepare detailed briefings for presentation to the Project Officer at a location(s) to be designated by the Project Officer, which may include the Project Officer's facility located in Pittsburgh, PA or Morgantown, WV. The Recipient shall make a presentation to the NETL Project Officer/Manager at a project kick-off meeting held within ninety (90) days of the project start date. At a minimum, annual briefings shall also be given by the Recipient to explain the plans, progress, and results of the technical effort and a final project briefing prior to the close of the project shall also be given.

The Recipient shall also provide monthly E-mail updates on the status of the project to the FPM.

## TABLE OF CONTENTS

Tandis S. Bidgoli, Assistant Scientist .....	1
INTRODUCTION .....	2
A. OBJECTIVES.....	2
B. SCOPE OF WORK.....	2
C. TASKS TO BE PERFORMED .....	2
D. DELIVERABLES .....	6
E. BRIEFINGS/TECHNICAL PRESENTATIONS .....	7
ACCOMPLISHMENTS.....	10
Task 1.0 – Project Management and Planning Integrated CCS for Kansas (ICKan) .....	10
Subtask1.1 - Fulfill requirements for National Environmental Policy Act (NEPA) documentation .....	10
Subtask 1.2- Conduct a kick-off meeting to set expectations .....	10
Subtask 1.3- Conduct regularly scheduled meetings and update tracking .....	10
Subtask 1.4 - Monitor and control project scope.....	11
Subtask 1.5 - Monitor and control project schedule .....	11
Subtask 1.6 - Monitor and control project risk.....	11
Subtask 1.7 - Finalize the DMP.....	12
Subtask 1.8 - Revisions to the PMP after submission .....	12
Subtask 1.9 - Develop an integrated strategy/business plan for commercial scale CCS.....	12
Task 2.0 – Establish a Carbon Capture and Storage (CCS) Coordination Team.....	12
Subtask 2.1 - Identify additional CCS team members.....	12
Subtask 2.2 - Identify additional stakeholders that should be added to the CCS team.....	12
Subtask 2.3 - Recruit and gain commitment of additional CCS team members identified.....	12
Subtask 2.4 - Conduct a formal meeting that includes the Phase I team and committed Phase II team members .....	12
Task 3.0 – Develop a plan to address challenges of a commercial-scale CCS Project.....	14
Subtask 3.1 - Identify challenges and develop a plan to address challenges for CO <sub>2</sub> capture from anthropogenic sources .....	14
Subtask 3.2 - Identify challenges and develop a plan to address challenges for CO <sub>2</sub> transportation and injection (non-technical) .....	16
Subtask 3.3 - Identify challenges and develop a plan to address challenges for CO <sub>2</sub> storage in geologic complexes (non-technical).....	16
Subtask 3.2 - Identify challenges and develop a plan to address challenges for CO <sub>2</sub> transportation and injection ( <i>Technical</i> ) .....	20
Subtask 3.3- Identify challenges and develop a plan to address challenges for CO <sub>2</sub> storage in geologic complexes ( <i>Technical</i> ) .....	20
Task 4.0 – Perform a high level technical sub-basinal evaluation using NRAP and related DOE	



tools.....	20
Subtask 4.1 - Review storage capacity of geologic complexes identified in this proposal and consider alternatives.....	20
Subtask 4.2 - Conduct high-level technical analysis of suitable geologic complexes using NRAP-IAM-CS and other tools for integrated assessment.....	22
Subtask 4.3 - Compare results using NRAP with methods used in prior DOE contracts including regional and sub-basin CO <sub>2</sub> storage .....	36
Subtask 4.4 - Develop an implementation plan and strategy for commercial-scale, safe and effective.....	36
Task 5.0 – Perform a high level technical CO <sub>2</sub> source assessment for capture .....	37
Subtask 5.1- Review current technologies and CO <sub>2</sub> sources of team members and nearby sources using NATCARB, Global CO <sub>2</sub> Storage Portal, and KDM .....	37
Subtask 5.2- Determine novel technologies or approaches for CO <sub>2</sub> capture .....	41
Subtask 5.3- Develop an implementation plan and strategy for cost effective and reliable carbon capture.....	42
References.....	43
Task 6.0 – Perform a high level technical assessment for CO <sub>2</sub> transportation.....	44
Subtask 6.1 - Review current technologies for CO <sub>2</sub> transportation .....	44
Subtask 6.2- Determine novel technologies or approaches for CO <sub>2</sub> transportation.....	44
Subtask 6.3 - Develop a plan for cost-efficient and secure transportation infrastructure.....	44
Task 7.0 – Technology Transfer.....	51
Subtask 7.1- Maintain website on KGS server to facilitate effective and efficient interaction of the team .....	51
Subtask 7.2 - Public presentations.....	61
Subtask 7.3 - Publications .....	61
Organizational Chart .....	62
Gantt Chart and Accomplishments.....	64
Budgetary Information.....	65
Cost Plan Status .....	65
Appendices .....	66
Appendix A .....	66
Appendix B .....	73
Appendix C.....	107

## ACCOMPLISHMENTS

### **Task 1.0 – Project Management and Planning Integrated CCS for Kansas (ICKan)**

#### **Subtask 1.1 - Fulfill requirements for National Environmental Policy Act (NEPA) documentation**

Environmental Questionnaire and Categorical Exclusion (CX) Designation forms were completed following notification of award in December of 2016.

#### **Subtask 1.2- Conduct a kick-off meeting to set expectations**

A kickoff meeting was held at the Kansas Geological Survey on February 14<sup>th</sup>, 2017. An overview of this meeting is provided on the ICKan project website at: <http://www.kgs.ku.edu/PRS/ICKan/news.html#KICK>

#### **Subtask 1.3- Conduct regularly scheduled meetings and update tracking**

The Legal, Regulatory and Public Policy (LRPP) team meetings:

February 14, 2017 – full team and partners at the KGS

March 21, 2017 – Stover and Dubois met in Topeka with Kansas Corporation Commission staff Jeff McClanan, Director of Utilities, Leo Haynos, Pipeline Safety, and Justin Grady, Accounting & Fiscal Analysis. KCC regulates utilities and set rates, and do permitting for pipelines. We informed them about the study's objectives and got valuable comments on areas where they would review any potential final CCS. They all expressed interest in being kept informed and are willing to provide guidance from their expertise.

March 28, 2017 – Stover met in Wichita with Ryan Hoffman, Director, Conservation Division, Kansas Corporation Commission. KCC's Conservation Division permits Class II injection wells and gas storage sites. It was the previous Conservation Division Director that had been involved with developing draft regulations for CCS.

April 14, 2017 – The LRPP team (Stover, DeBois, Christiansen, Steincamp and Schremmer) teleconferenced to review a draft framework document: *Assessment of the Legal and Regulatory Issues to Address for Large-Scale Geologic Storage in Kansas*. This document frames key issues, status, potential next steps, team leader(s), external contacts that may help, and background, discussions and questions.

April 17, 2017 – The LRPP team teleconferenced with Doug Louis, the former KCC Conservation Division Director. Discussed history of the previous legislative and regulatory attempts to provide a framework to allow commercial scale CCS. Also got Mr. Louis's ideas on how to proceed, based on past challenges. Mr. Louis, and the LRPP team discussed possible advantages to developing a CCS as a utility. Mr. Louis expressed interest in staying involved.

April 21, 2017 – The LRPP team teleconferenced with Judge Teresa James, a legal expert on pipelines. She spoke in generalities and of course, gave no legal opinions. However, she did agree with the discussions we had with Mr. Louis and others that developing a CCUS pipeline as a part of a geologic storage public utility may be an effective approach.

April 22, 2017 – Stover met in Boulder Colorado with Fred McLaughlin, Carbon Management Institute,

University of Wyoming. Discussed Wyoming's approach to CCS study.

May 19, 2017 – Dubois, Brad Crabtree, Eric Mort and Jeff Brown met and discussed CO2 pipelines in Midwest.

May 27, 2017 – Steincamp met with Doug Louis, former Conservation Director of the Kansas Corporation Commission. Discuss generally KCC adoption of CO2 storage regulations and their subsequent revocation by the agency.

May 2, 2017 – The LRPP team, including Bidgoli (KGS) and Jordan (GPI) teleconferenced with Kipp Coddington, Director, Carbon Management Institute, University of Wyoming. Wyoming has a significantly different political and economic climate for CCUS. Wyoming is a coal rich state and there is strong interest in finding ways to keep coal a viable option for energy needs. We discussed setting up a CCS project as a free-standing utility. Discussed liabilities and how these were discussed in Congress (example, the Price-Anderson Act for nuclear energy industry). Neither the State of Kansas or Wyoming has yet legally clarified whom would assume long term liability for a project. In 2008, Wyoming legislated establishment of a working group to examine these issues (IOGCC, 2014). Coddington thought liabilities issues with CCS may be debated in Wyoming's legislature in 2017.

#### Full Team Meetings:

March 17, 2017 – The full team went over upcoming activities for the quarter, including the CarbonSAFE meeting in Pittsburgh and expectations for the project. Updates were provided by each group and a routine evaluation of deadlines was discussed.

June 14, 2017 – The full team went over updates that addressed the scope of work. A review of the timelines and tasks was conducted, and a brief outline of the quarterly report was assembled to direct the team in compiling accomplishments. Members gave an in-depth overview of their work that would be integrated into the quarterly report.

#### KGS Team Meetings:

Regular KGS team meetings were held on the third Thursday of each month, alternating with meetings scheduled with the full team. Goals of these meetings were to provide an overview of ongoing work and evaluate progress on deliverables. Frequent individual meetings were held on an as-needed basis throughout the course of the reporting period as well.

### **Subtask 1.4 - Monitor and control project scope**

The KGS held regular monthly and bimonthly meetings with the team to discuss the status of deliverables and evaluate tasks. Participants provided a brief overview of their work and discussed steps forward.

### **Subtask 1.5 - Monitor and control project schedule**

The project schedule was reviewed during monthly and bimonthly meetings with the team.

### **Subtask 1.6 - Monitor and control project risk**

Risks were evaluated in an ongoing basis within normal workflow. Larger concerns were presented in team meetings where in depth discussions could be held.

### **Subtask 1.7 - Finalize the DMP.**

Data will be delivered to DOE upon completion of models for efficiency. This is planned for completion by October 2017.

### **Subtask 1.8 - Revisions to the PMP after submission**

Nothing to report.

### **Subtask 1.9 - Develop an integrated strategy/business plan for commercial scale CCS**

Part of the agenda for the meeting scheduled for September 2017 includes a discussion on commercial scale CCS. A summary of the outcome of these discussions will be compiled as follow up to the meeting and presented in Fall '17.

## **Task 2.0 – Establish a Carbon Capture and Storage (CCS) Coordination Team**

### **Subtask 2.1 - Identify additional CCS team members**

Identified disciplines and some individuals

### **Subtask 2.2 - Identify additional stakeholders that should be added to the CCS team**

Identified areas and some individuals

### **Subtask 2.3 - Recruit and gain commitment of additional CCS team members identified**

Process has begun. To be completed by Fall 2017

### **Subtask 2.4 - Conduct a formal meeting that includes the Phase I team and committed Phase II team members**

To be completed by Fall, 2017

### **Significant activities and accomplishments in the reporting period for Task 2 include the following:**

- Reviewed objectives and requirements for CarbonSAFE's Phase II FOA (DE-FOA-0001450).
- Identified team disciplines and sub disciplines, both technical and non-technical that are not currently filled by the current ICKan team members.
- Identified additional stakeholder areas not currently filled in the current ICKan team.
- Initiated the process to identify and recruit individuals/organizations.

Table 1 provides a summary of additional team members and stakeholders, their role, and status in a Phase II CCS team.

	Discipline/Area	Sub Discipline	More Specific	Role/Purpose in Phase II	Status
<b>Additional Team Members</b>	<b>Geologic Analysis</b>	Rock mechanics specialist		Evaluate rock-mechanical seal risks.	Need identified. Recruit in next quarter.
		Monitoring specialist(s)		Design site-specific monitoring plans.	Need identified. Recruit in next quarter.
		Geophysics - 2D/3D seismic		Design, implement acquisition, and interpret 3D seismic covering geologic sites(s).	Need identified. Recruit in next quarter.
	<b>Business</b>	Finance, business, economic modeling		Explore various business models for implementing CCS economically.	Need identified. Individual identified. Recruit in next quarter.
	<b>Legal and Regulatory</b>	Business contract law		Work with business/finance expert and CO2 source personnel to define range of required contracts.	Need identified. Recruit in next quarter.
<b>Additional Stakeholders</b>	<b>Stakeholders</b>	State Regulatory	KCC - Utilities and Conservation (Oil & Gas) Divisions	Understand current regulatory framework, help develop appropriate changes, set stage for gaining support for modifications.	Key KCC staff identified; may expand. Meetings held with KCC.
		State Legislature	Key legislators and committee chairs	Act as a sounding board and gain support for proposed changes in Kansas laws related to CCS.	Determine whether appropriate for Phase II. Recruit if needed.
		Mineral, pore space, and surface owners	Kansas Independent Oil & Gas Assoc. (KIOGA)	Act as a sounding board and gain support for proposed changes in Kansas laws related to CCS.	Need identified. Recruit in next quarter.
			SW Kansas Royalty Owners Assoc. (SWKROA)		Need identified. Recruit in next quarter.
		Additional CO2 sources	Ethanol industry operators and organizations	Explore various business models for implementing CCS economically.	Determine whether appropriate for Phase II. Recruit if needed.
		CO2 transportation	KCC pipeline safety staff.	Provide perspective and input on pipeline systems	Determine whether appropriate for Phase II. Recruit industry if needed.
		NGO environmental groups		Act as sounding board and gain support for CCS project(s) in Kansas.	Determine whether appropriate for Phase II. Recruit if needed. Initial list of NGOs identified.

**Table 1.** Additional team members and stakeholders to complete the ICKan CCS team for Phase II.

### Goals and objectives for the next Quarter:

The primary goals for the next quarter are to 1) complete the task of identifying individuals or organizations to fill the gaps identified in our current CCS team that should be filled for Phase II, and 2) begin the recruitment process for gaining commitments to participate in Phase II. This needs to be completed prior to a meeting including the current ICKan team and stakeholders and those recruited for Phase II that is yet to be scheduled. This meeting is likely to occur in October or early November, 2017.

**Products for Task 2:** None to report.

### **Task 3.0 – Develop a plan to address challenges of a commercial-scale CCS Project**

#### **Subtask 3.1 - Identify challenges and develop a plan to address challenges for CO<sub>2</sub> capture from anthropogenic sources**

A plan will be developed that addresses CO<sub>2</sub> capture including use of plant configuration, current and anticipated operating conditions, product distribution (e.g. electrical power grid), and regulatory uncertainty.

The ICKan proposal presented three candidate sources for CO<sub>2</sub> capture. The objective of Phase I work is to determine which are most feasible, and to identify and develop a preliminary plan to address the unique challenges of each source that may be feasible for commercial-scale CCS (50+ million tonnes captured and stored in a saline aquifer). Although no time frame was defined by FOA15824 for the processing of 50 million tonnes, the ICKan project set 2.5 million tonnes/year over a 20-year period as a target.

#### **Summary of Activities:**

The team has identified three CO<sub>2</sub> emission sources that can potentially deliver the targeted CO<sub>2</sub> volumes for the ICKan EOR utilization/ geological storage sites. Along with other members of the ICKan team, Linde made site visits to two of the potential CO<sub>2</sub> sources in Kansas, Jeffrey Energy Center and CHS Refinery, to establish relationships with the operations personnel and familiarize the facilities with the goals of the ICKan project. These sites include the following:

- a. **Westar Energy Company's Jeffrey's Energy Center:** A large coal-fired power plant located in St. Mary's KS, is composed of three separate 800 MWe (megawatt electricity) units with annual CO<sub>2</sub> emissions on the order of 12.5 million tonnes. This plant can deliver the entire CO<sub>2</sub> capture volume targeted for ICKan through partial carbon capture of flue gas from one of the three units (~350MWe).
- b. **CHS Inc. Refinery hydrogen reformers:** The largest potential single point sources for CO<sub>2</sub> at CHS refinery in McPherson KS are two steam methane reformer (SMR) based hydrogen plants that yield approximately 760,000 tonnes of CO<sub>2</sub> per year (~30% of the ICKan project current annual target). The refinery has other CO<sub>2</sub> emissions from mainly boilers and fired heaters that total approximately 624,000 tonnes/year. However, these sources are distributed throughout 27 different locations within the refinery, with the largest (the CO boiler that treats the Fluid Catalytic Cracker (FCC) regenerator gas) producing just 150,000 tonnes/year. If the targeted time frame was expanded to fifty years, consideration could be given to combining CO<sub>2</sub> captured from one or more of the seven larger Kansas ethanol plants (with CO<sub>2</sub> emissions ranging from 105 to 330 thousand tonnes annually) with the estimated 760,000 tonnes from the CHS hydrogen reformers to meet the 50 million tonnes goal.
- c. **SunFlower Power Plant:** This is a 350 MW power plant located in Holcomb, KS. Although this unit generates enough CO<sub>2</sub> emissions to meet the project's target sequestration volumes and rates, there will be some parasitic losses due to the operation of the power plant. This source would therefore be a less attractive power plant option when compared to the Jeffrey's Energy Center.

An in-depth discussion with the operations and facilities support staff at the two locations identified a number of key challenges that will have to be addressed for successful completion of project goals.

**Significant Results/Key Outcomes:**

A summary of the challenges for CO<sub>2</sub> capture from the identified anthropogenic sources is shared in Table 2. The table also contains a preliminary action plan to address these challenges.

<u>Location</u>	<u>Challenges</u>	<u>Mitigation Plans</u>
<u>Westar Jeffrey's Energy Center</u>	<ul style="list-style-type: none"> <li>Lack of baghouse may contribute to aerosol formation in flue gas, and solvent carry-over/ losses from the column.</li> </ul>	<ul style="list-style-type: none"> <li>Measure particle size distribution and evaluate their impact on amine carry-over. Make provisions towards reducing aerosol particles in the flue gas at source.</li> </ul>
	<ul style="list-style-type: none"> <li>Concerns about the long term power plant coal utilization capacity with cheap natural gas and increasing wind power generation.</li> </ul>	<ul style="list-style-type: none"> <li>Continue to monitor fuel mix in Westar's energy portfolio. Select a carbon capture solution also applicable to natural gas emissions.</li> </ul>
	<ul style="list-style-type: none"> <li>Heat recovery from identified waste heat sources present technical challenges for recycle.</li> </ul>	<ul style="list-style-type: none"> <li>Thorough evaluation by Linde Engineering will determine appropriate heat exchanger design for feasible heat extraction.</li> </ul>
<u>CHS Inc. Refinery</u>	<ul style="list-style-type: none"> <li>Refinery CO<sub>2</sub> emissions distributed throughout facility and in small amounts and there is little opportunity to capture excess heat from current operations.</li> </ul>	<ul style="list-style-type: none"> <li>Combine flue gas from the two reformers for option of largest scale capture. This flue gas (~ 300°F) will also provide waste heat that can be utilized by the capture process if appropriate.</li> </ul>
	<ul style="list-style-type: none"> <li>Total CO<sub>2</sub> emissions from plant does not meet project's target for sequestration and utilization over time period.</li> </ul>	<ul style="list-style-type: none"> <li>Combination of SMR H<sub>2</sub> plants with other industrial capture including ethanol (fermentation) sources may provide improved overall economics.</li> </ul>
	<ul style="list-style-type: none"> <li>Refinery is short on steam with sources distributed throughout the facility.</li> </ul>	<ul style="list-style-type: none"> <li>Additional steam generation from a new gas-fired boiler is being considered for refinery needs as well as generation of low pressure steam for solvent reclamation in capture process.</li> </ul>
	<ul style="list-style-type: none"> <li>Availability of excess utilities for CO<sub>2</sub> capture is unfavorable - solvent based technologies use steam for CO<sub>2</sub> regeneration, PSA/VSA sorbent based technologies require electric power to drive the compressor or vacuum pumps.</li> </ul>	<ul style="list-style-type: none"> <li>The choice of CO<sub>2</sub> capture technology will take into account the availability of steam and power in the reformer as well as the economics of capture.</li> </ul>

**Table 2:** Challenges and potential mitigations for CO<sub>2</sub> capture from identified anthropogenic sources.

**Goals and objectives for the next Quarter:**

During preliminary design, scheduled for the next quarter, continue to evaluate and modify or improve

possible mitigation solutions to the challenges presented.

### **Products for Subtask 3.1:**

Table 2 illustrating challenges and possible mitigation plans for capture from two CO<sub>2</sub> source sites.

### **Subtask 3.2 - Identify challenges and develop a plan to address challenges for CO<sub>2</sub> transportation and injection (non-technical)**

### **Subtask 3.3 - Identify challenges and develop a plan to address challenges for CO<sub>2</sub> storage in geologic complexes (non-technical)**

**Note** - The SOPO combined technical and non-technical aspects of the Phase I project in Task 3, in particular Subtasks 3.2 and 3.3. To simplify for reporting and for the reader, the technical and non-technical are discussed separately. Furthermore, the non-technical subject matter pertaining to Subtasks 3.2 and 3.3 have considerable overlap and will be combined for this and future reports.

#### Subtasks 3.2 and 3.3 Non-Technical Section:

### **Overview**

The ICKan Legal, Regulatory and Public Policy team (LRPP), is comprised of attorneys from Depew Gillen Rathbun & McInterer, public policy experts from Great Plains Institute and the Kansas Geological Survey outreach manager. In this quarter they 1) identified key non-technical challenges for transportation, injection, and storage, 2) defined the current conditions/status in Kansas, 3) developed possible remedies to address the challenges, and 4) developed, or, have begun developing plans and strategies for implementation.

### **Significant activities in the reporting period for Subtasks 3.1 and 3.2 include the following:**

- Research and compile data and references on the following:
  - Kansas statutory framework relative to injection and storage of fluids and gas, including CO<sub>2</sub>.
  - Other States' legislation and regulations related to pore space, CO<sub>2</sub> injection and long-term storage (Johnson, 2010; MGA, 2011).
  - Model statutory framework proposed by various organizations
- Meetings with outside individuals and organizations for data gathering, discussions on current status of rules and regulations, and feedback on conceptual plans, including, but not limited to the following:
  - Kipp Coddington, University of Wyoming, regarding the State of Wyoming statutes covering CO<sub>2</sub> injection and long-term storage, and Class VI primacy by States.
  - Honorable Teresa James, Federal Magistrate Judge, regarding pipeline right-of-way issues, eminent domain, and the "Utility Scheme" option. In her former law practice, pipelines were a major component of her practice.
  - Kansas Corporation Commission, Utilities Division, regarding a range of issues surrounding the capture and transportation of CO<sub>2</sub> from coal-fired power plants (economics, long-term viability of coal-fired power, pipeline safety and regulatory jurisdictions).
  - Former Director of the Conservation Division of the Kansas Corporation Commission, whom resided over the organization when they adopted initial CO<sub>2</sub> storage regulations which were later rescinded.
- Team and sub-team meetings to develop strategies and plans to address non-technical challenges



**Significant accomplishments in the reporting period for Subtasks 3.1 and 3.2 include the following:**

Table 3 summarizes the ICKan’s legal, regulatory and public policy team’s significant activities and accomplishments for the non-technical challenge issues in Subtasks 3.2 and 3.3.

- Defined significant challenges to CO<sub>2</sub> transportation, injection and storage for CCS in Kansas.
- Defined current status, conditions, and political climate related to the challenges defined.
- Defined remedies or mitigation efforts that could resolve the challenges for CCS in Kansas.
- Initiated the development of a plan for implementation.
- Legal and regulatory – completed draft model statutes (Appendix A) that if enacted by the Kansas legislature would pave the way for CCS transportation, injection, and storage in Kansas. The current Kansas statute (Carbon Dioxide Reduction Act, K.S.A. 2016 Supp. 55-1636 through 55-1640) is inadequate, was implemented through Kansas Corporation Commission temporarily, and later rescinded. The model statutes would supplement and greatly expand the existing legislated statute. Key elements of the model statutes address the following:
  - Pore space ownership
  - Establish that CO<sub>2</sub> capture and storage is in the public interest (IOGCC 2014 recommendation).
  - Allow businesses that the transport inject and store CO<sub>2</sub> to be classified as utilities, thereby providing for powers of eminent domain for purposes of acquiring pipeline right of ways and securing rights to underground pore space for CO<sub>2</sub> storage.
  - Provide statutory mechanisms to address long-term liability.
- Began the process for defining an implementation plan for the sweeping changes.

In addition to challenges and possible remedies specific to Kansas involvement by the federal government is critical in the areas of large-scale CO<sub>2</sub> pipeline infrastructure (Brown et al., 2017, NETL 2017) and incentives for capture, transportation, and long-term storage (Brown et al., 2016).

Challenge Category	Specific Challenge	Current Conditions (Kansas)	Remedy	Plan Status
<b>Statutory framework</b>	<i>This is an overarching challenge whose components are more specifically defined</i>	Current law is adequate for injection and storage related to oil and gas production and the temporary storage of hydrocarbons. These statutes are not directly applicable to CO2 injection for long-term storage.	Expand statutory framework specific to capture, transportation, injection and long-term storage. This could include statutes to deploy CCS under a Utility Scheme.	Background research completed and ideal comprehensive remedies defined. Implementation plan being formulated.
<b>Pore space</b>	Ownership - who owns the pore space?	Based on judicial precedent, pore space ownership likely resides with the surface estate. Pore space ownership should be clarified.	Create a statute whereby pore space is defined and the surface estate owner is the owner of the pore space.	Background research completed and a simple model statute could be written. Implementation plan being formulated.
	Aggregation or pooling of pore space	Under current law, aggregation of reservoirs for CO2 storage might be governed by KCC regulations for EOR (KSA 1301-1313), which allow for unitization of pore space. There is no force-pooling making it difficult to aggregate pore space for both EOR and CO2 storage.	Create a statute governing CO2 injection and storage that includes force-pooling. <i>OR put in place the required statutes to deploy Utility Scheme.</i>	Background research completed and a draft model statute has been written. Implementation plan being formulated.
<b>Transportation</b>	ROW difficulties	Obtaining ROW for pipelines is difficult and expensive without eminent domain and condemnation authority.	Put in place the required statutes to deploy a Utility Scheme that would allow the application of eminent domain and condemnation authority.	Background research completed and a draft model statutes have been written. Implementation plan being formulated.
<b>Regulation of Injection and Storage</b>	Class VI well permitting	EPA rules and regulations (952 pages) is a critical impediment. KGS has a 3-yr history with the EPA on a small pilot project that is yet to be approved.	Streamline the current EPA rules and regulations. Seek Kansas primacy for regulating CCS in Kansas.	The KGS already has extensive experience with Class VI permitting problems. No additional work to report at this time.
	CO2 ownership from emission through capture, transportation and injection	Under current law the owner of the CO2 would be determined on a contractual basis.	Create a statute whereby the owner of CO2 in the context of a geologic storage project is the storage operator up to the point of site closure. <i>OR put in place the required statutes to deploy Utility Scheme.</i>	Background research completed and draft model statutes for the Utility Scheme have been written. Implementation plan being formulated.
	Post-closure, long-term liability is costly and a major impediment	Under current law the owner of the CO2 would be determined on a contractual basis.	Create a statute whereby the owner of post-closure owner of the CO2 is the State. <i>OR put in place the required statutes to deploy Utility Scheme.</i>	Background research completed and draft model statutes for the Utility Scheme have been written. Implementation plan being formulated.
<b>Public acceptance</b>	Capture	A large segment of Kansans is unlikely to support the basic premise that CCS is desirable.	Develop a CCS plan that clearly demonstrates economic feasibility and overall positive impact on the Kansas economy. Develop a public outreach program for future deployment.	Challenge understood and outlined. Comprehensive CCS plan, including public outreach, is being formulated.
	Transportation	Historically Kansas has been pipeline friendly.	<i>Same as above</i>	<i>Same as above</i>
	Injection and storage	Historically, Kansas has accepted injection of fluids (waste disposal, EOR) and storage (hydrocarbons). However, recent induced seismicity related to high-rate brine disposal may be a public acceptance hurdle.	Develop a technical plan that limits risk of induced seismicity and other risks by careful site selection, controlled injection rates, robust monitoring plan and mitigation options. Develop a public outreach program for future deployment.	<i>Same as above</i>

**Table 3:** Non-technical challenges for CCS, current status or conditions in Kansas, remedies and status of plan to address challenges.

**Goals and objectives for the next Quarter (non-technical):**

- Address Class VI well permitting issues
  - Review the experience that the KGS has had with permitting a Class VI well under a current contract (DE-FE0006821) and identify problem areas in the permitting process
  - Define modifications to the current regulations that would streamline and improve the process without compromising safety and ensuring permanency.
  - Gather and study information regarding North Dakota's pursuit for State primacy over Class VI permitting.
  - Develop a plan or improving current Class VI permitting and, if determined appropriate, the State of Kansas to seek primacy.
- Finalize plans to enable the adoption of sweeping legal and regulatory requirements for CCS in Kansas, including plans for 1) obtaining feedback for modifications and refinements to the plan and proposed statutes, 2) gaining acceptance and support from key stakeholders, and 3) and implementation the proposed changes.
- Organize and conduct a meeting with key stakeholders in collaboration with the State CO<sub>2</sub>-EOR Deployment Work Group, managed by Great Plains Institute (<http://www.betterenergy.org/>). Half of the one-day meeting will be devoted to the ICKan project and half for the Work Group's efforts in developing infrastructure for CO<sub>2</sub> transport for CCS and EOR. The meeting is scheduled for September 21, 2017 at the DoubleTree airport hotel.

**Products for Subtasks 3.2 and 3.3 (non-technical):**

- Table outlining non-technical challenges for CCS, current status or conditions in Kansas, remedies and status of plan to address challenges (Table 3).
- Draft model statutes that if enacted by the Kansas legislature would pave the way for CCS transportation, injection, and storage in Kansas (Appendix A).

**References:**

Brown, J., et al, 2017, 21<sup>st</sup> Century Energy Infrastructure: Policy Recommendations for Development of American CO<sub>2</sub> Pipeline Networks, February 2017, White Paper prepared by the State CO<sub>2</sub> – EOR Deployment Work Group. <https://law.stanford.edu/publications/21st-century-energy-infrastructure-policy-recommendations-for-development-of-american-co2-pipeline-networks/>

Brown, J., et al., 2016, Putting the Puzzle Together: State & Federal Policy Drivers for Growing America's Carbon Capture & CO<sub>2</sub> – EOR Industry, Steyer-Taylor Center for Energy Policy and Finance, December, 2016, white paper prepared by the State CO<sub>2</sub> – EOR Deployment Work Group. [https://www-cdn.law.stanford.edu/wp-content/uploads/2017/03/Final\\_Puzzle\\_PolicyDriversCO2\\_EOR\\_2016.pdf](https://www-cdn.law.stanford.edu/wp-content/uploads/2017/03/Final_Puzzle_PolicyDriversCO2_EOR_2016.pdf)

Carbon Dioxide Reduction Act, K.S.A. 2016 Supp. 55-1636 through 55-1640, 79-233 and 79-32,256, and amendments thereto, may be cited as the carbon dioxide reduction act. [http://www.kslegislature.org/li/b2017\\_18/statute/055\\_000\\_0000\\_chapter/055\\_016\\_0000\\_article/055\\_016\\_0036\\_section/055\\_016\\_0036\\_k/](http://www.kslegislature.org/li/b2017_18/statute/055_000_0000_chapter/055_016_0000_article/055_016_0036_section/055_016_0036_k/)

Interstate Oil and Gas Compact Commission (IOGCC) Task Force on Carbon Capture and Geologic Storage, 2014, L. E. Bengal, K. Bliss, and K. Connors, Guidance for States and Provinces on Operational and Post-Operational Liability in the Regulation of Carbon Geologic Storage, September 0214, National Energy Technology Laboratory, White paper. Online: [http://iogcc.ok.gov/Websites/iogcc/images/CO2\\_phase\\_III\\_guidelines\\_FINAL.pdf](http://iogcc.ok.gov/Websites/iogcc/images/CO2_phase_III_guidelines_FINAL.pdf)

Johnson, J., 2009, Midwest Governors' Association, Energy Security and Climate Stewardship Platform for the Midwest, Legal and Regulatory Inventory for Carbon Capture and Storage & Analogues, March 2009, Great Plains Institute, white paper. <http://www.midwesterngovernors.org/resolutions/Platform.pdf>

Midwestern Governors Association, 2011, Key Components of a state-level statutory & regulatory framework to support deployment of carbon capture and storage (CCS) in the Midwest, May 2011. <https://docs.google.com/document/d/1VvnbOfKc7zg1oEOFnEkIYJ9L08eMQ6K6YNxVIwrc9r4/edit>

National Energy Technology Laboratory and the Great Plains Institute, 2017, Siting and Regulating Carbon Capture, Utilization and Storage Infrastructure, Workshop Report, January 2017, U.S. Department of Energy. <https://energy.gov/epa/downloads/workshop-report-siting-and-regulating-carbon-capture-utilization-and-storage>

Subtasks 3.2 and 3.3 Technical Section:

### **Subtask 3.2 - Identify challenges and develop a plan to address challenges for CO<sub>2</sub> transportation and injection (*Technical*)**

*Also see Task 3.2 and 3.3 non-tech quarterly.docx*

**Summary of significant activities:** None to report

**Significant Results/Key Outcomes:** NA

**Goals and objectives for the next Quarter:** NA

### **Subtask 3.3- Identify challenges and develop a plan to address challenges for CO<sub>2</sub> storage in geologic complexes (*Technical*)**

*Also see Task 3.2 and 3.3 non-tech quarterly.docx*

**Summary of significant activities:**

- Key risks were defined for the Davis Ranch and John Creek Fields during the process of the high-level technical evaluation.
- Key risks were defined for the Pleasant Prairie field during the data gathering phase.

**Significant Results/Key Outcomes:** None to report

**Goals and objectives for the next Quarter:**

- Develop plans to address risks for geologic sites it is determined they have the capacity to store >50mT CO<sub>2</sub>

## **Task 4.0 – Perform a high level technical sub-basinal evaluation using NRAP and related DOE tools**

### **Subtask 4.1 - Review storage capacity of geologic complexes identified in this proposal and consider alternatives**

Three possible sites in two complexes are in various stages of analysis and each appears to meet the 50+Mt

storage requirement. They shall be evaluated further and a survey of other potential geologic structures will undergo a rigorous site screening and selection process to determine suitability.

### Overview:

The two geologic complexes identified as potential sites for storing >50 million tonnes (Mt) are the Pleasant Prairie field geologic site in the Hugoton Embayment storage, considered the primary storage site, and the Davis Ranch and John Creek fields, in the Forest City Basin storage complex, considered a secondary site. Prior to applying for funding for this project the Pleasant Prairie site was estimated to have a capacity of 170 Mt and, in combination, the Davis ranch and John Creek, an estimated 50Mt capacity. The estimates were based on simple deterministic models created in CMG's Builder and simulated in CMG's GEM. Alternatives to the two geologic complexes selected for this project are sites identified by regional characterization study under DE-FE0002056. The study completed in 2015, identified nine potential sites capable of storing >50 Mt.

### Summary of significant activities:

- The Davis Ranch and John Creek fields, in the Forest City Basin storage complex, were characterized, modeled and simulated for storage capacity and injectivity.
- Data gather and initial data analysis for the Pleasant Prairie site was performed.
- Nine alternative sites identified in the completed DE-FE0002056 were reviewed and prioritized.

### Significant Results/Key Outcomes:

- It was determined that the Davis Ranch and John Creek fields, in combination, probably do not meet the >50Mt capacity standard. Please see discussion of modeling and simulation results under Subtask 4.2.
- The nine alternative sites capable of storing 50 Mt CO<sub>2</sub> identified in the completed DE-FE0002056 were narrowed to four for further study. Figure 1 shows the ten sites in the saline aquifer study, two of the four CO<sub>2</sub> source industry partners, and the Pleasant Prairie field. Study area 2 did not meet the 50Mt minimum and areas 1, 3, 5, 9, and 10 were given lower priority because of proximity to a current gas storage field (3), higher induced seismicity risk (1 and 5), and proximity to Class I Arbuckle disposal wells with rising water levels.

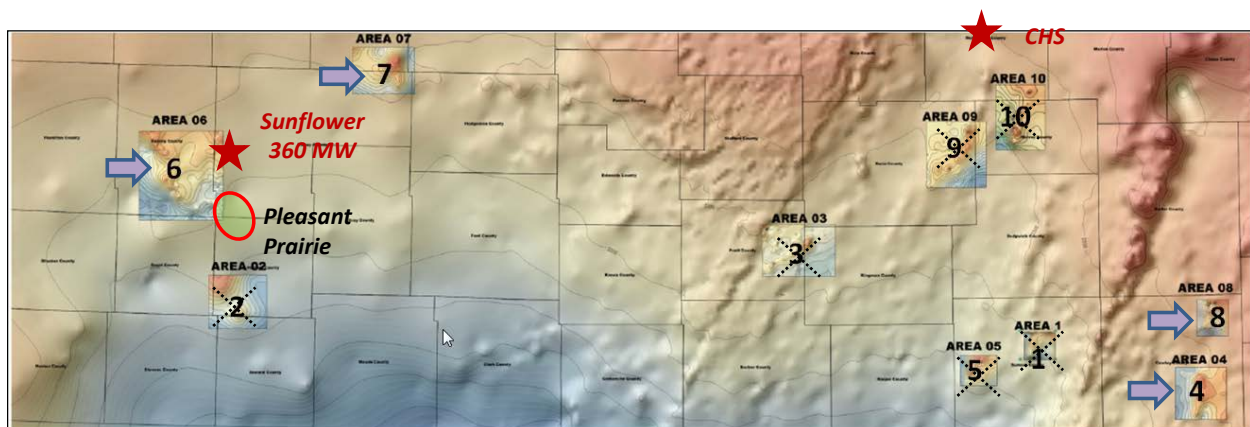

**Figure 1:** Location of four alternate CO<sub>2</sub> storage sites (arrows) being evaluated (modified from Watney et al., 2015).

### Goals and objectives for the next Quarter:

- The primary goal for the next quarter is to confirm storage capacity of >50Mt in the Pleasant Prairie and one or two alternate sites.

**Products for Subtask 4.1:**

- Preliminary technical report for the Davis Ranch and John Creek fields in the Forest City Basin geologic complex (Appendix B).

**Subtask 4.2 - Conduct high-level technical analysis of suitable geologic complexes using NRAP- IAM-CS and other tools for integrated assessment**

The KGS shall evaluate candidate storage complexes in terms of capacity, seal, faults, seismicity, pressure, existing wellbores, and injectivity.

**Summary of significant activities:**

Table 4 summarizes activities and work completed by the ICKan technical team related to Subtasks 4.1 and 4.2.

- The Davis Ranch and John Creek fields, in the Forest City Basin storage complex, were characterized, modeled and simulated for storage capacity and injectivity, and work on technical risks was initiated.
- High-level technical analysis was initiated on the Pleasant Prairie site and one alternate site, the Lakin site, Area 6 in Figure 1.

	<b>FCB - Davis Ranch and John Creek</b>	<b>Pleasant Prairie</b>	<b>Alternative Site (Area 6 - Lakin)</b>
<b>Volumetric capacity and injectivity</b>			
Data gather and process	complete	complete	complete
Well log analysis and tops	complete	partial	partial
Petrophysics	complete	partial	
2D models	complete	partial	
3D models	complete		
Volumetric (capacity)	complete		
Simulate for injectivity	complete		
<b>Technical risks</b>			
Seals - geochemistry	complete	partial	
Seals - mechanical	NA		
Fault leakage	NA	partial	
Seismicity	NA		
Wellbores	NA		
<b>Implementation plan</b>			
Injection plan	NA		
Monitor plan	NA		

**Table 4:** Summary of technical analysis activities and work completed on potential geologic sites. NA indicates analysis that may be completed if the site is determined incapable of storing 50Mt CO<sub>2</sub>.

**Significant Results/Key Outcomes:**

**Key outcome 1:** Davis Ranch and John Creek high-level technical analysis (capacity, injectivity, seals)

It was determined that the two fields that make up the Forest City Basin storage complex, the Davis Ranch and John Creek fields, in combination, are unlikely to be capable of storing 50Mt of CO<sub>2</sub>. Storage capacity (Table 5) was estimated in two ways: 1) a simple volumetric estimate based on the 3D static model (9.23 Mt at 1200 psi), and 2) injection and storage simulated in a dynamic model (24.6 Mt at higher pressures). For the static model calculation, the volume of pore spaces above the structure's spill point was first calculated and then the volume of CO<sub>2</sub> that could occupy that space at 70% saturation under reservoir conditions (1200 psi and 110F). Because CO<sub>2</sub> density is very sensitive to pressure a small increase in pressure results in a relatively large increase in storage capacity (Table 6).

<b>Davis Ranch</b>		
<b>Parameter</b>	<b>Simpson Ss</b>	<b>Arbuckle</b>
Depth	3300	3400
BHT	106.9	110.0
BHP	1160	1160
Spill point (subsea)	-1970	-2035
Closure	~100ft	~100ft
Storage BHT and BHP	110F, 1200psi	110F, 1200psi
CO <sub>2</sub> Density (lb/ft <sup>3</sup> )	17.15	17.15
CO <sub>2</sub> saturated PV (%)	0.7	0.7
PV above spill point (Bft <sup>3</sup> )	0.466	0.213
<b>CO<sub>2</sub> stored (M tonnes)</b>	2.54	1.16
<b>John Creek</b>		
<b>Parameter</b>	<b>Simpson Ss</b>	<b>Arbuckle</b>
Depth	3170	3250
BHT	106.4	107.9
BHP	1100	1160
Spill point (subsea)	-1850	-1915
Closure	~100ft	~100ft
Storage BHT and BHP	110F, 1200psi	110F, 1200psi
CO <sub>2</sub> Density (lb/ft <sup>3</sup> )	17.15	17.15
CO <sub>2</sub> saturated PV (%)	0.7	0.7
PV above spill point (Bft <sup>3</sup> )	0.432	0.584
<b>CO<sub>2</sub> stored (Mt)</b>	2.35	3.18
<b>Total stored at 1200 psi (Mt)</b>	<b>4.89</b>	<b>4.34</b>
Combined Simpson & Arbuckle		<b>9.23</b>

**Table 5.** Estimated reservoir capacity for CO<sub>2</sub> storage Forest City Basin complex (Davis Ranch and John Creek Fields) based on static model volume calculations. Capacities are in millions of tonnes CO<sub>2</sub>. CO<sub>2</sub> density is from Kansas Geological Survey, 2003.



CO2		
Pressure (psig)	Density (lbs/ft <sup>3</sup> )	Stored (Mt)
1200	17.2	9.2
1300	22.6	12.2
1400	30.6	16.4
1600	39.6	21.3
1800	43.3	23.3

**Table 6.** Estimated storage capacity for the combined Davis ranch and John Creek fields as a function of pressure. Temperature is constant at 110F. Capacities are in millions of tonnes CO2. CO2 density is from Kansas Geological Survey, 2003.

Simulated injections rates are satisfactory at rates averaging 2700 tonnes/day (0.98 Mt/yr) in the tow fields over a 25-yr period. Initial work on evaluating the vertical seals, comparing the geochemistry of the reservoir brines, suggests that the target CO2 injection zones, the Simpson and Arbuckle, are isolated from each other as well as from overlying strata. Additional risk evaluations have been postponed because of the apparent shortfall in reservoir capacity. Below is a summary of the technical work on the Davis Ranch and John Creek that is more fully documented in Appendix B.

**Setting**

The Davis Ranch and John Creek fields, numbered 11 and 12 in Figure 2, were chosen for this study largely due to their proximity to the Jeffrey Energy Center, the largest CO2 source in Kansas.

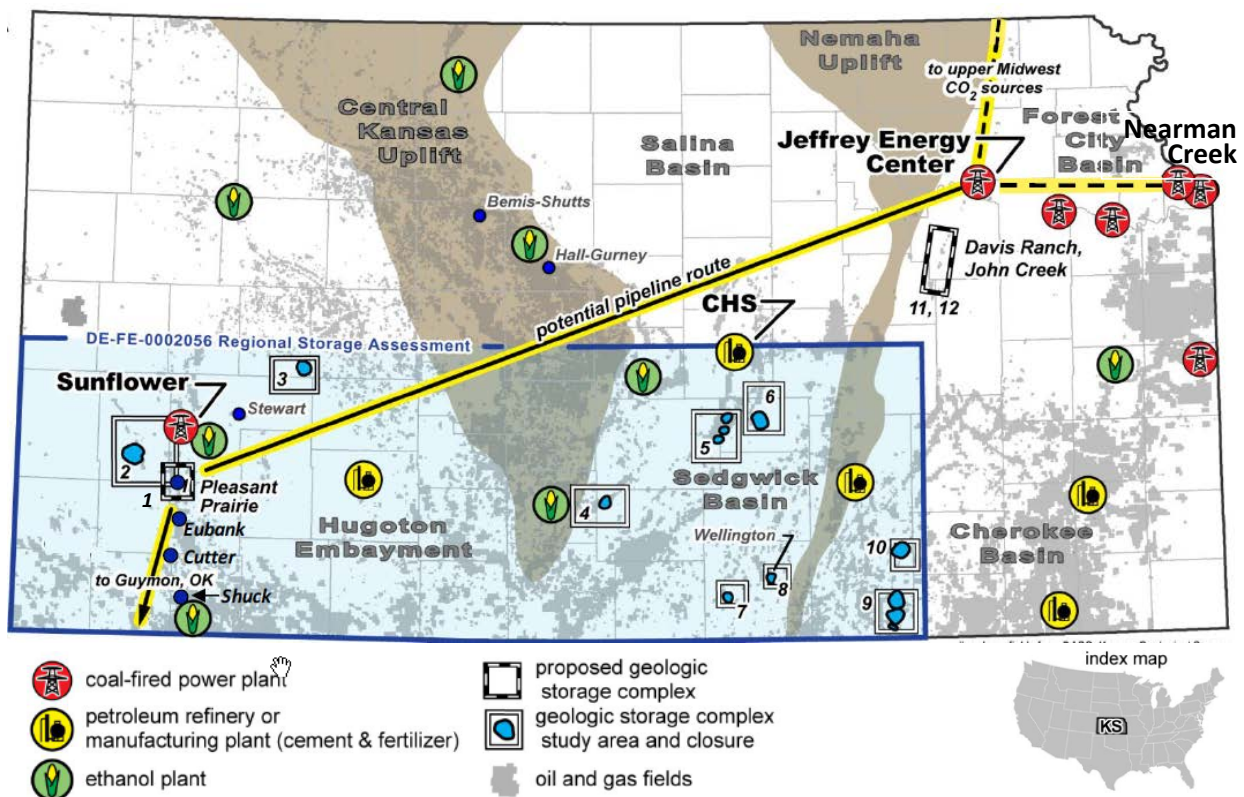



**Figure 2.** Kansas map showing possible CO<sub>2</sub> injections sites (numbered 1-12), CO<sub>2</sub> sources, possible CO<sub>2</sub> pipeline routes, DE-FE0002056 study areas (blue), and oil fields (modified from ICKan proposal SF 424 R&R, 2016).

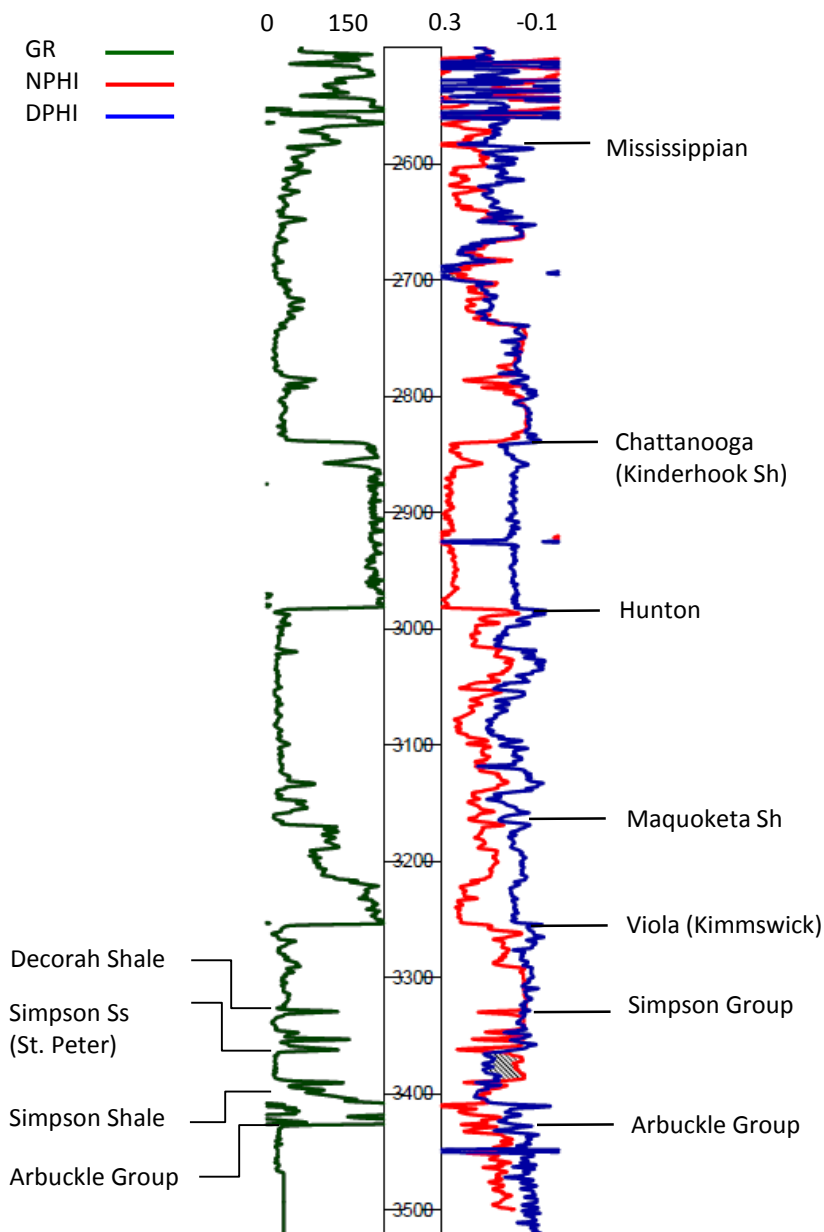

**Figure 3.** Generalized stratigraphic column for the Davis Ranch and John Creek area. Wireline log is from the Conoco, Inc. #1 Fisher Grace well in Morris County, Kansas (API 15-127-2045). Abbreviations included GR – natural gamma ray radiation in API counts, NPHI – neutron porosity expressed in decimal, DPHI – density porosity expressed in decimal.

**Workflow**

A simple, unfaulted 3D static model was built for a 418 mi<sup>2</sup> (1082 km<sup>2</sup>) area (Figure 4) and then smaller areas were cut out of the model for simulation. A standard workflow (Figure 4) for building a 3D static model was deployed: 1) gather, prepare and analyze well-scale well data from public sources and operator-partner data, 2) build 2D structure and isopach maps with Geoplus Petra™, 3) develop petrophysical relationships to estimate permeability knowing porosity, 4) build a larger-area 3D static property model populated with porosity and permeability for the Simpson Sandstone and Arbuckle, 5) upscale the model to reduce cell counts for simulation, and 6) cut out and export smaller field-scale models for simulating the two fields.

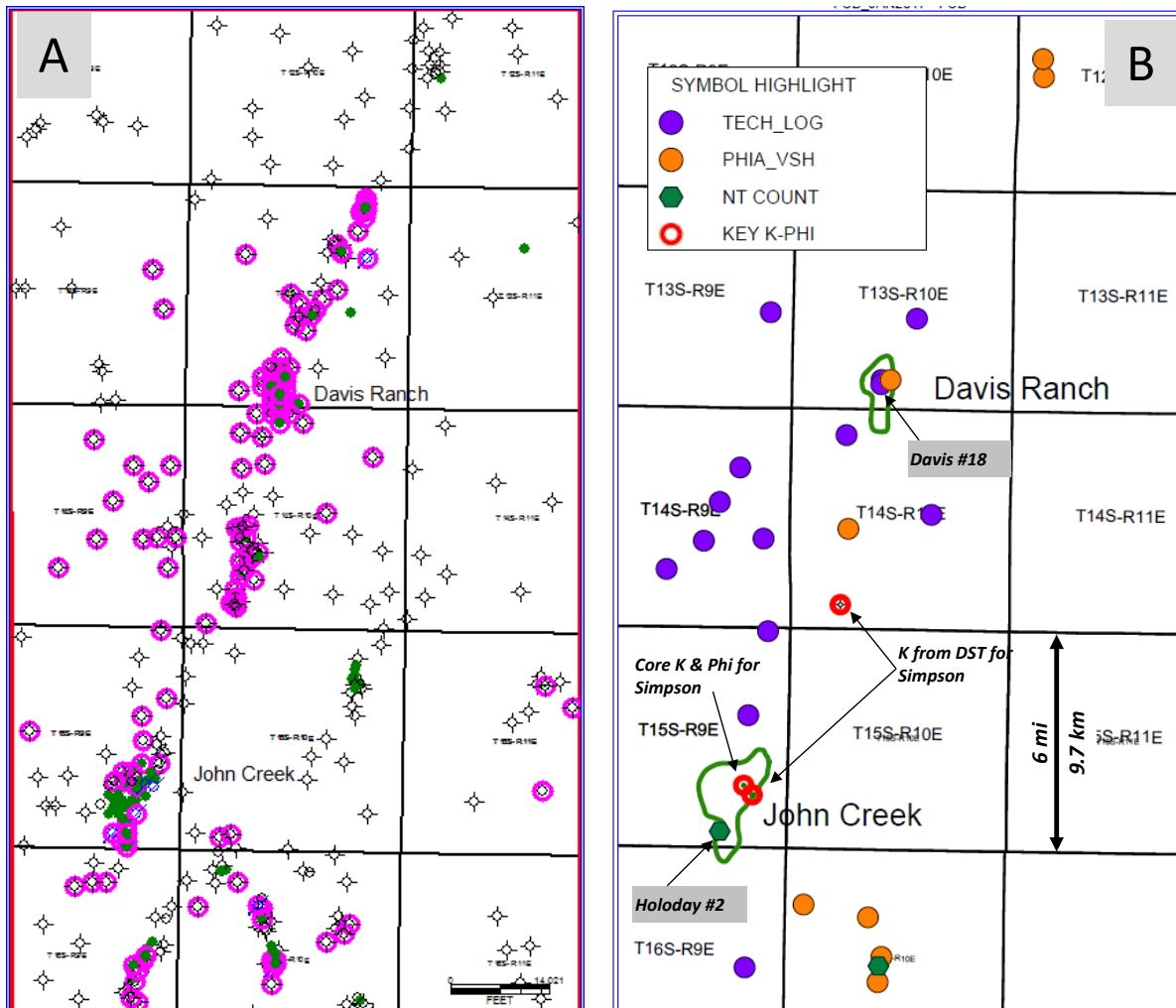

**Figure 4.** Davis Ranch and John Creek model areas. (A) 518 wells in the model with raster image logs available for 145 wells (circled). (B) Solid-fill symbols are wells with digital logs (n=25). Open circles are wells with Simpson Sandstone permeability estimated from drill stem tests (n=2) and core permeability (n=1).

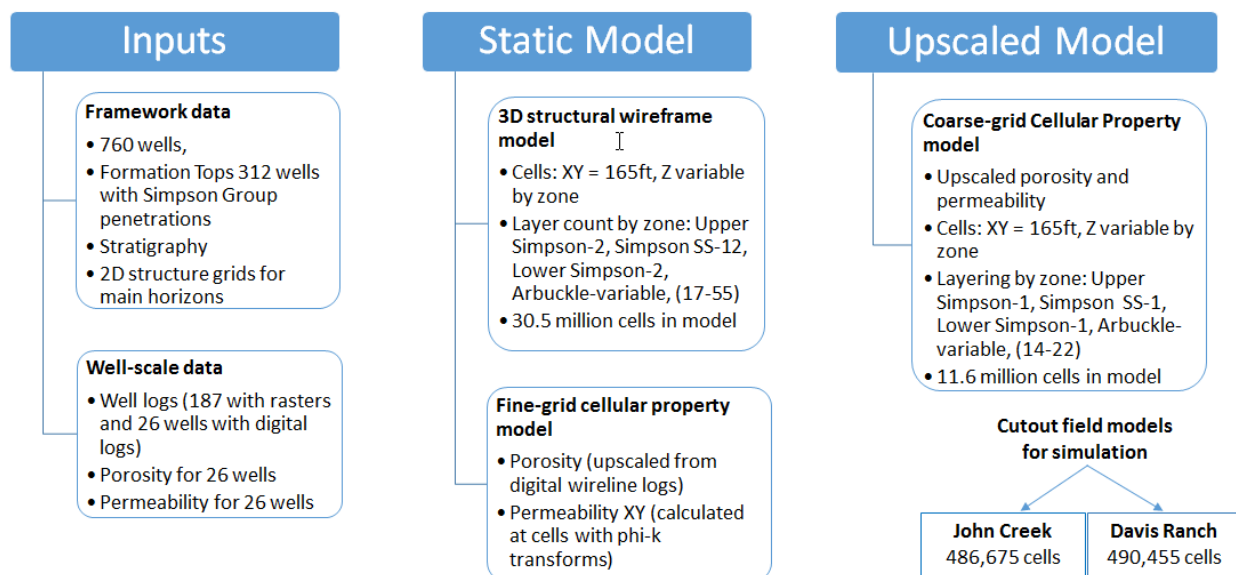

**Figure 5.** Diagram outlining the data used and workflow for construction of static geologic models

### *Petrophysics*

Although petrophysical work in the study area was constrained by very limited data we are confident the main properties, porosity and permeability, are well characterized in the Simpson and Arbuckle. Because most of the drilling took place in the 1950s there is a limited number wells with modern logs that penetrated the target injection zones, 23 wells denoted Tech\_Log and Phi\_Vsh (Figure 6). Porosity was calculated using Techlog™ for 15 wells and average neutron-density porosity corrected for shale volume was used for eight wells. Neutron count logs from two wells were calibrated for porosity in two wells, including a key well, the Holoday #2, the deepest penetration in the Arbuckle (216 ft).

Two independent, empirically-based methods for the permeability solution the Simpson were deployed, with both having similar results (Table 6). For the Arbuckle, again two different (from the Simpson) independent, empirically-based methods were used, again with similar results. Core analysis data was available in one well for the Simpson Sandstone (Kinzey 4) and a porosity-permeability transform (Figure 6) based on that data was used to estimate permeability at the half-foot scale in the 25 wells with digital porosity. Permeability calculated from drill stem test buildups in two nearby wells (Vincent 1 and Eldridge 4) are consistent with the core analysis data.

Permeability was determined for the Holoday 2, a saltwater disposal well in the Arbuckle where 1600 barrels of brine are disposed daily in 198 ft of open hole, on a vacuum. Having the injection rate, estimated bottom hole injection pressure and static pressure, an injectivity Index was calculated. The injectivity Index was then used in the Darcy equation of radial flow and permeability was calculated for 198 ft open hole in the Arbuckle. There is no Arbuckle core data available in the region. The second method for estimating permeability was using a neural network function trained on Arbuckle NMR-derived permeability data for the Berexco LLC #1-32 KGS Wellington well, a science well in the small-scale field demonstration project (DE-FE0006821) located approximately 120 miles southwest of this study area. Despite the distance, the permeability estimates using this method were similar to that derived by the local injection data and helps validate the permeability data (Table 6). A porosity-permeability transform that was applied to other wells was generated by cross plotting porosity and permeability from neural networks for the Davis 18 and

Warren 1 wells (Figure 6). Permeability calculated using this transform are 22 mD, 14 mD, and 24 mD for the Holoday 2, Davis 18, and Warren 1 wells.

	Average K (mD)	h (ft)	Kh (mD-ft)
<b>Simpson</b>			
Core Analysis (Lucy B Kiefer 4)	105	23	2415
DST Buildup (Vincent 1)	56	25	1400
DST Buildup (Eldridge 4)	182	25	4550
<b>Arbuckle</b>			
Injectivity Index	18	198	3564
Neural Network (Holoday 2)	13	198	2574
Neural Network (Davis 18)	19	60	1140
Neural Network (Warren 1)	27	64	1728

**Table 6.** Permeability for the Simpson Sandstone and the Arbuckle. Abbreviations include K – permeability, h – height, mD – millidarcies, and DST – drill stem test.

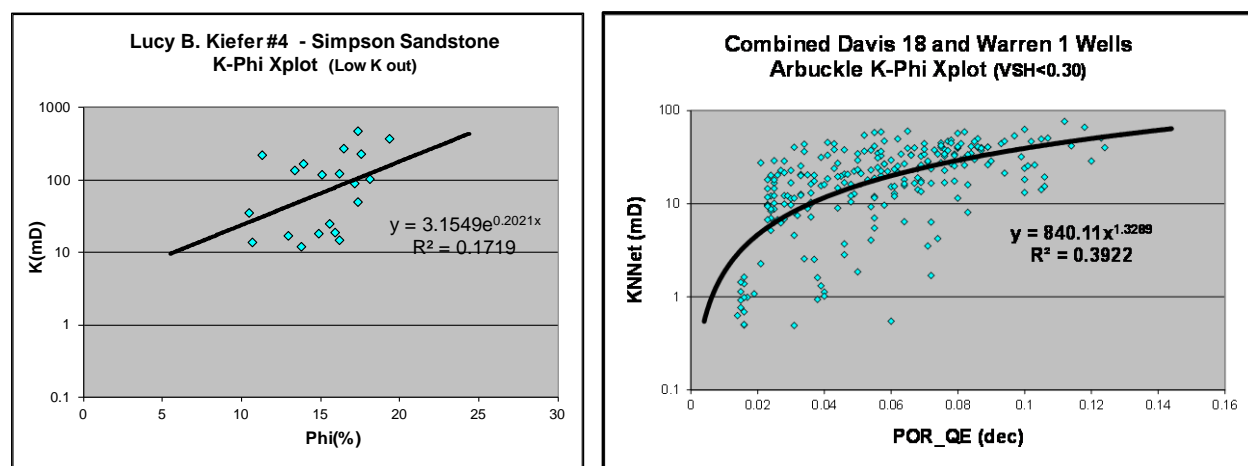

**Figure 6.** Porosity –Permeability transform equations by regression for Simpson Sandstone and Arbuckle.

### 3D static model

The two target CO<sub>2</sub> injection zones, the Simpson Sandstone and Arbuckle, were modeled for evaluating injectivity and capacity for storing CO<sub>2</sub>. The sealing intervals, Decorah Shale above the Simpson Sandstone, and Simpson Shale above the Arbuckle and between it and the Simpson Sandstone were not modeled other than for thickness. Data was gathered and processed in Geoplus Petra™ and then imported into Petrel™ for 3D cellular modeling. Because of 1) the high density of the data in the Viola, 2) the conformance of the structure on the target zones below, and 3) the limited penetrations below the Viola, a Viola structure 2D grid was constructed and the structure of the horizons below were generated by grid-to-grid operations with isopachous grids. Well-scale porosity at the half-foot was upscaled to layer-scale in the fine grid model, and the cells between the wells were modeled using Gaussian random function simulation. Permeability was calculated at the cell scale using the transform functions in Figure 5. The large-area models was then upscaled for simulation (Figure 7) and the field-scale areas were cut out and exported in a rescue format for simulation (Figure 8).

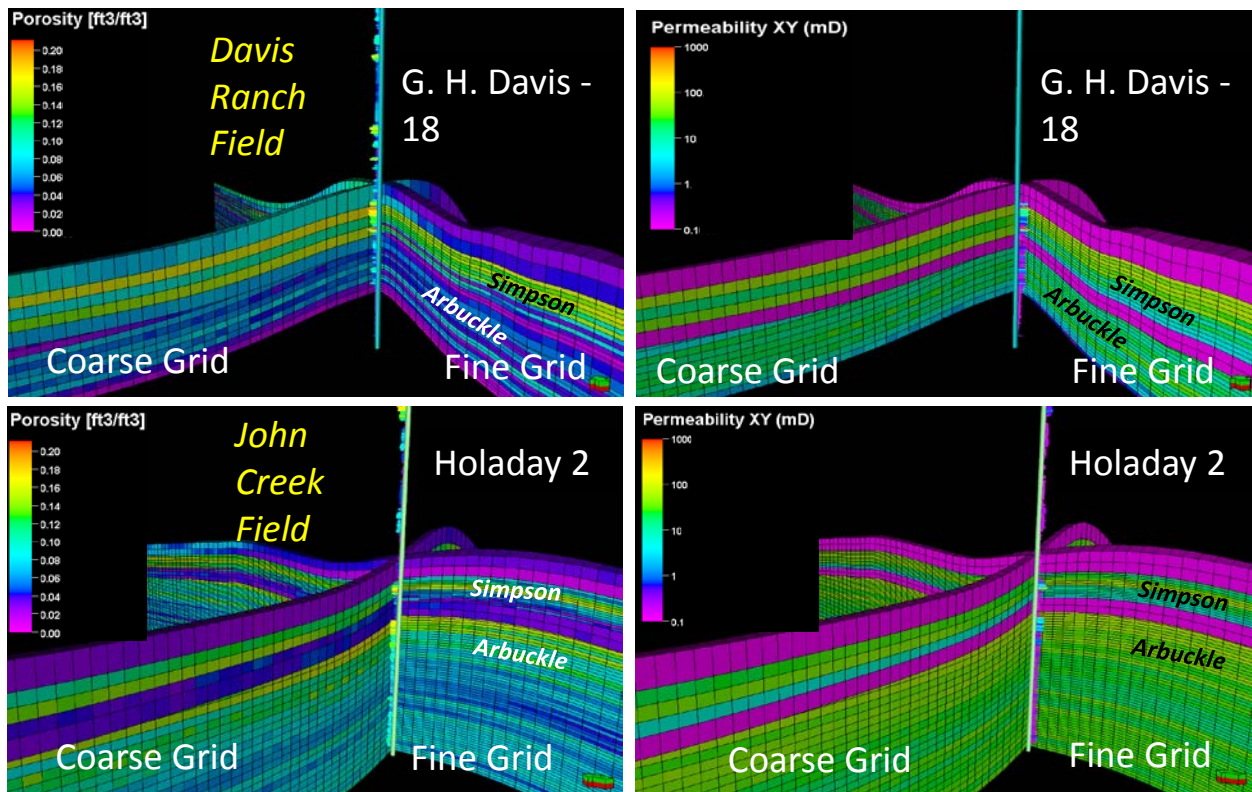

**Figure 7.** Intersecting cross sections demonstrating porosity and permeability Fence Diagrams of the Fine and Coarse Grid at key wells. VE=10

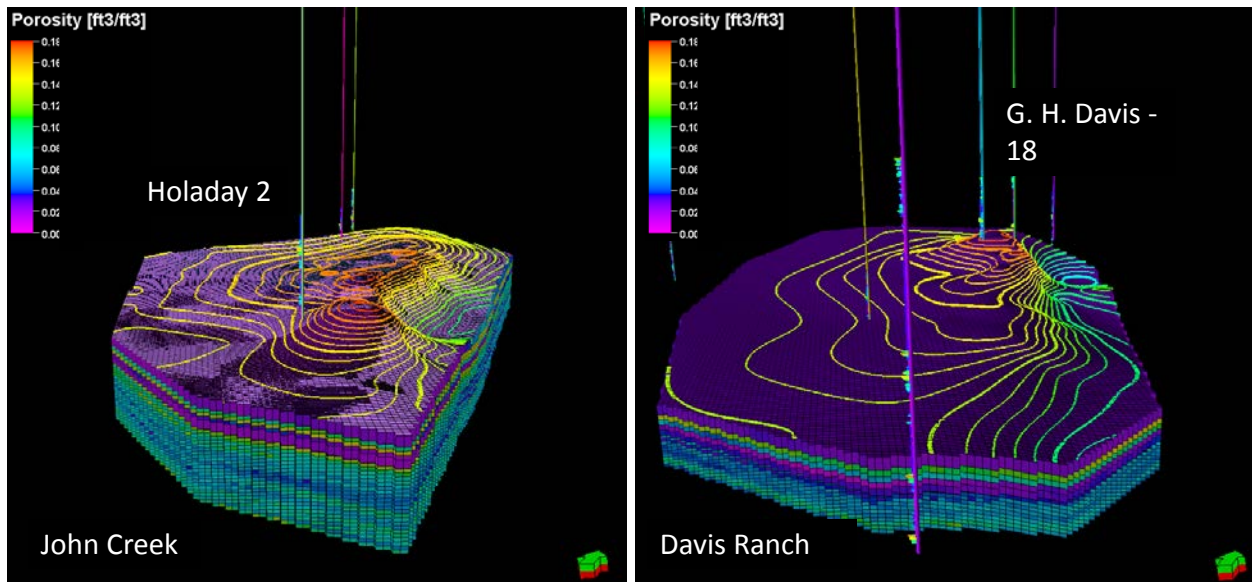

**Figure 8.** John Creek and Davis Ranch models extracted for simulation. Contours = 10 ft and vertical exaggeration = 10X.



### *Simulation model*

The key objectives of the dynamic modeling were to determine the volume of CO<sub>2</sub> stored, resulting rise in pore pressure and the extent of CO<sub>2</sub> plume migration in the two fields in the Forest City Basin storage complex. Simulations were conducted using the Computer Modeling Group (CMG) GEM simulator, a full equation of state compositional reservoir simulator with advanced features for modeling the flow of three-phase, multi-component fluids that has been used to conduct numerous CO<sub>2</sub> studies (Chang et al., 2009; Bui et al., 2010). A detailed discussion of the modeling and results is presented in Appendix B.

### Initial reservoir conditions and simulation constraints

The initial conditions specified in the reservoir two models are specified in Table 7. The simulations were conducted assuming isothermal conditions. Although isothermal conditions were assumed, a thermal gradient of 0.008 °C/ft was considered for specifying petrophysical properties that vary with layer depth and temperature such as CO<sub>2</sub> relative permeability, CO<sub>2</sub> dissolution in formation water, etc. The original static pressure in the injection zone was set to reported field test pressures and the Arbuckle pressure gradient of 0.48 psi/ft was assumed for specifying petrophysical properties. Perforation zone was set at all permeable layers in Simpson and Arbuckle reservoirs. Injection rate was assigned according to maximum calculated based on well tests and reservoir properties.

	<b>John Creek</b>	<b>Davis Ranch</b>
Temperature	41 °C (106 °F)	38 °C (100 °F)
Temperature Gradient	0.008 °C/ft	0.008 °C/ft
Pressure	1,160 psi (7.99 MPa)	1,200 psi (8.27 MPa)
TDS	30 g/l	24 g/l
Perforation Zone	Simpson, Arbuckle	Simpson, Arbuckle
Injection Period	25 years	25 years
Injection Rate	2,100-3,000 MT/day	350-940 MT/day
Total CO <sub>2</sub> injected	21,000,000 MT	3,600,000 MT

**Table 7.** Model input specification and CO<sub>2</sub> injection rates

Isothermal conditions were modeled because the total variation in subsurface temperature in the Arbuckle and Simpson intervals from the top to the base is only slightly more than 3°F, and because it is assumed that the temperature of the injected CO<sub>2</sub> will equilibrate to formation temperatures close to the well. Uniform salinity concentration was assumed. Subsurface storage of CO<sub>2</sub> occurs via the following four main mechanisms: structural trapping, aqueous dissolution, and hydraulic trapping.

Models were optimized for maximum CO<sub>2</sub> storage capacity potential. Three wells completed at Simpson and Arbuckle intervals were introduced in high structural points for both modeled sites. No-flow boundary conditions were specified along the top of the Simpson Formation based on brine chemistry data and other evidence. The lateral boundary conditions were set as an infinite-acting Carter-Tracy aquifer (Dake, 1978; Carter and Tracy, 1960) with leakage. This is appropriate since the Simpson and Arbuckle are open hydrologic systems extending over the Forest City Basin.

The bottom hole injection pressure in the Simpson and deeper Arbuckle should not exceed 90% of the

estimated fracture gradient of 0.75 psi/ft (measured from land surface) based on EPA and KDHE guidelines for UIC Class I & VI wells. Therefore, the maximum induced delta pressure at the top of Simpson and bottom of the Arbuckle should be less than 750 psi.

### Simulation results

Figure 9 shows the maximum lateral migration of the CO<sub>2</sub> plume approximately 25 and 15 years after cessation of CO<sub>2</sub> injection activities at John Creek and Davis Ranch sites respectively. The plume grows rapidly during the injection phase and is largely stabilized by the end of injection period. CO<sub>2</sub> travels throughout the reservoir for additional several years and enters stabilization phase after several years post injection commencement.

Figure 10 presents the distribution of reservoir pore-pressure at the maximum point of CO<sub>2</sub> injection. The pressure increases are estimated to be below 750 psi on commencement of injection and then pressure gradually drops after the commencement of the injection as the capillary effects are overcome. The pressure decreases to almost pre-injection levels after approximately 50 years.

Figures 11 and 12 illustrate modeled maximum injection rates and cumulative injection volumes obtained via injection by 3 injection wells completed at Simpson and Arbuckle intervals. Maximum combined for 3 wells injection rate modeled for Davis Ranch Field was 940 metric tonnes/day. Maximum combined for 3 wells injection rate modeled for John Creek was significantly higher at 3,000 metric tonnes/day. Overall, John Creek Field proved to be better suited for accommodating commercial CO<sub>2</sub> storage project. Although cumulative CO<sub>2</sub> injection was projected at 21MMT it is possible to improve this projection via altering injection strategies and by expanding modeled areal extent. Pressure at the injections sites during injection and post injection is shown in Figure 13.

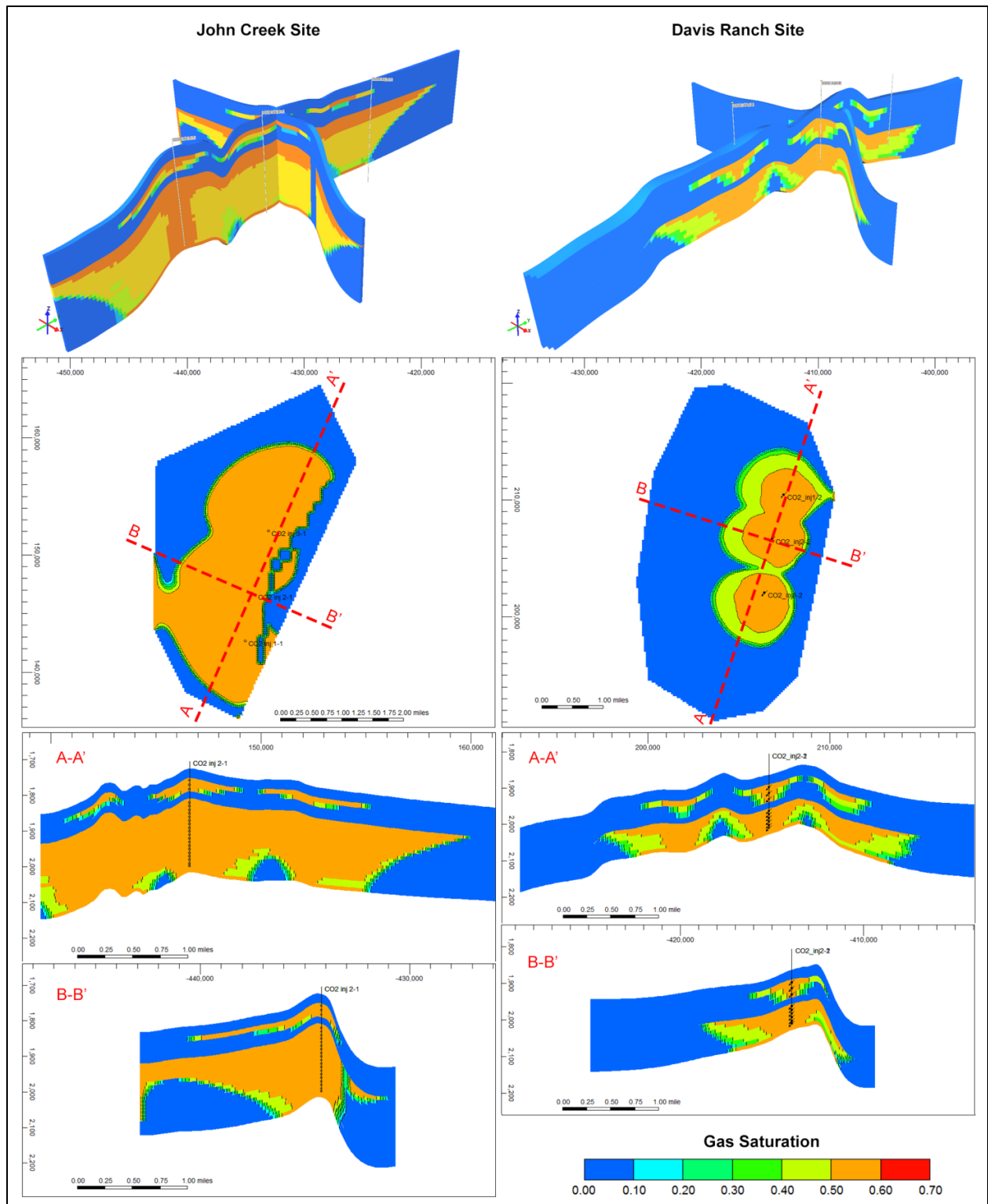
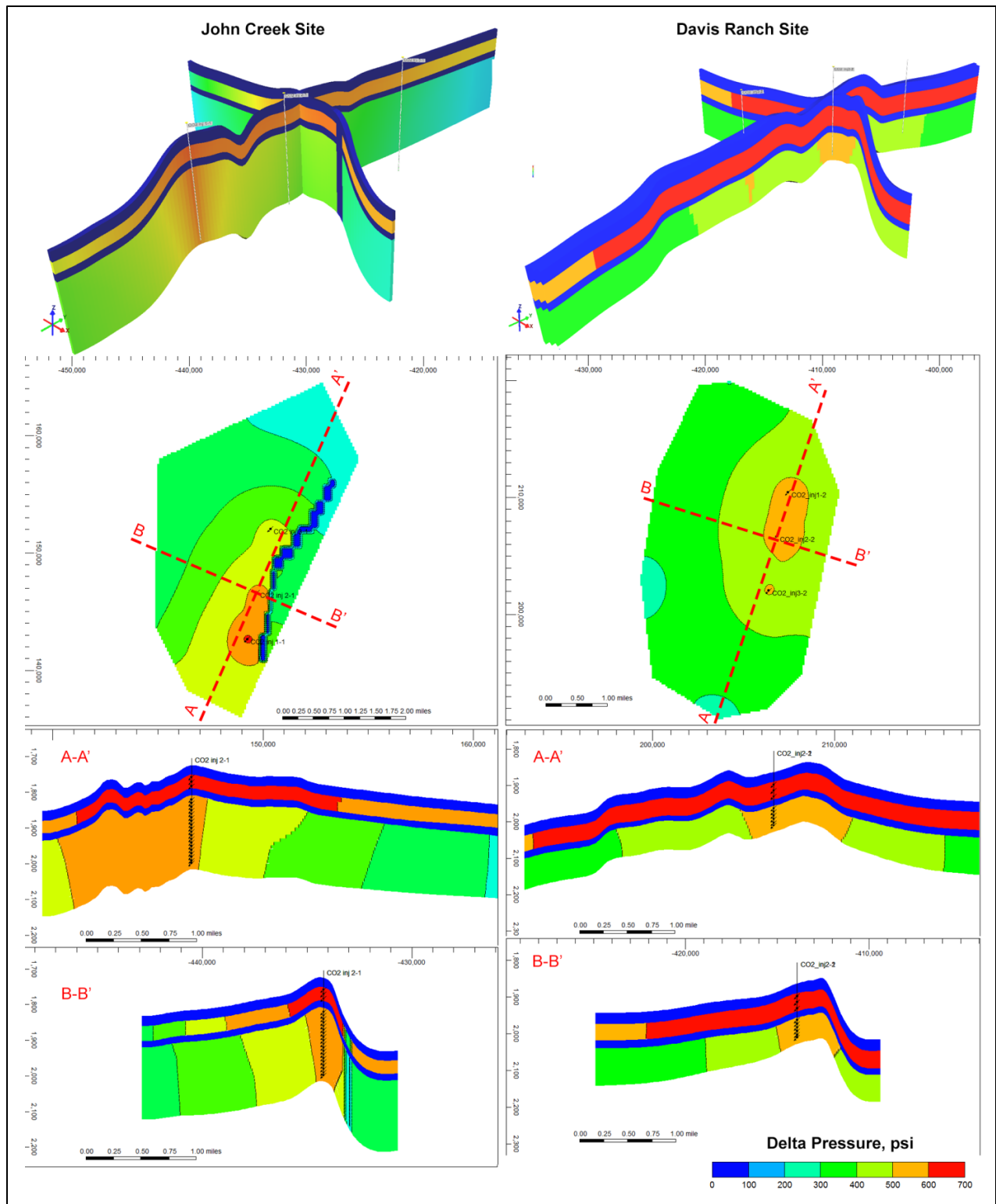
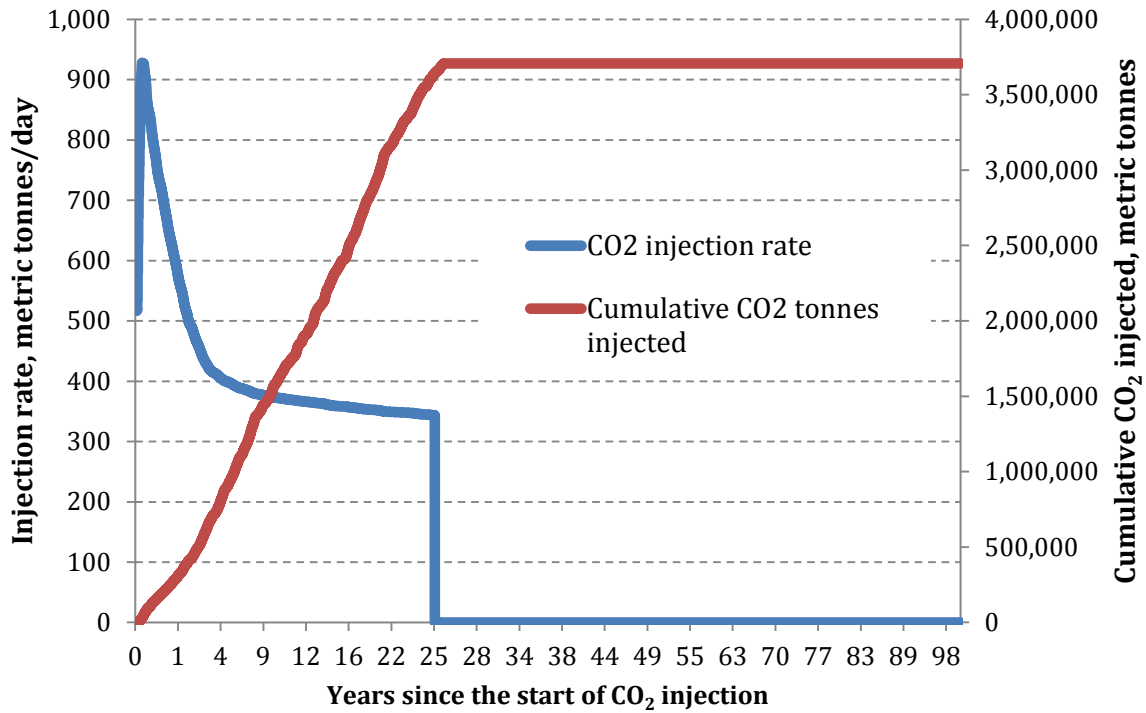

Figure 9. Maximum CO<sub>2</sub> plume distribution at John Creek (left) and Davis Ranch (right) sites

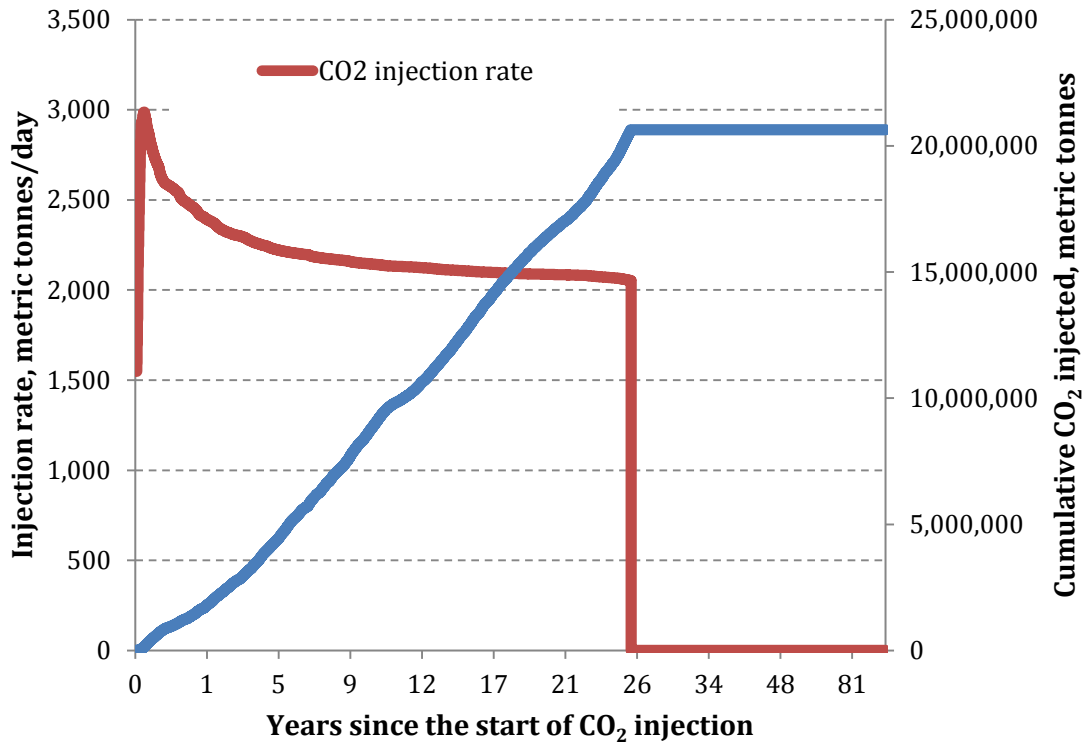



**Figure 10.** Maximum reservoir pressure increases as a result of CO<sub>2</sub> injection at John Creek (left) and Davis Ranch (right) sites



**Figure 11.** Cumulative CO<sub>2</sub> injected and CO<sub>2</sub> injection rate for Davis Ranch site. This plot accounts for 3 wells completed at two intervals: Simpson and Arbuckle.



**Figure 12.** Cumulative CO<sub>2</sub> injected and CO<sub>2</sub> injection rate for John Creek site. This plot accounts for 3 wells completed at two intervals: Simpson and Arbuckle.

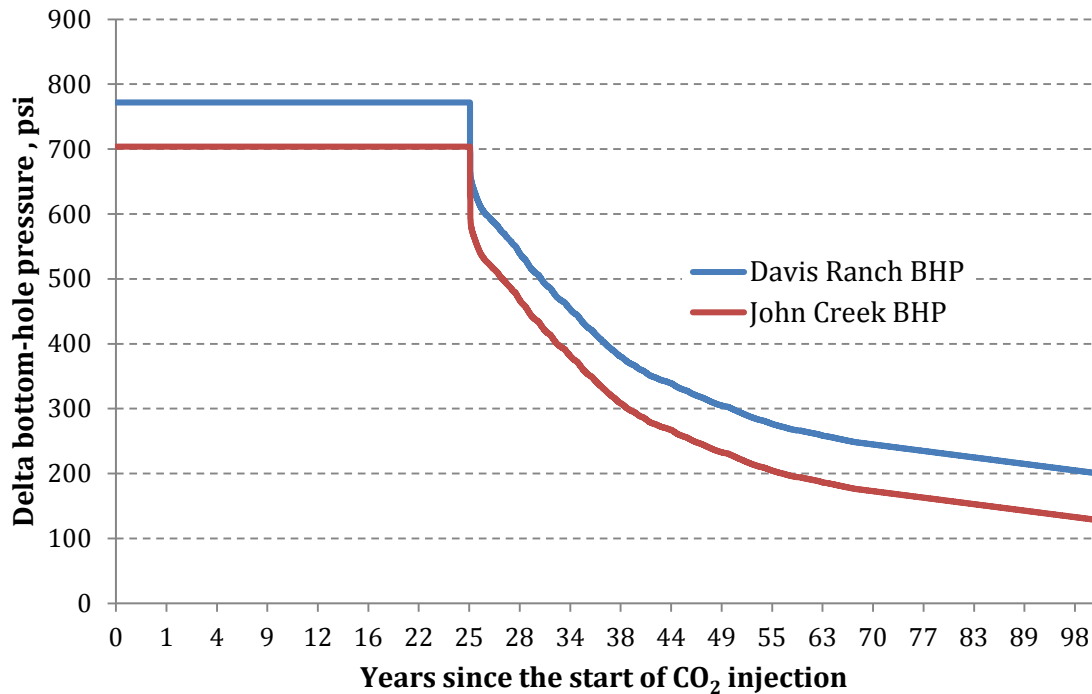
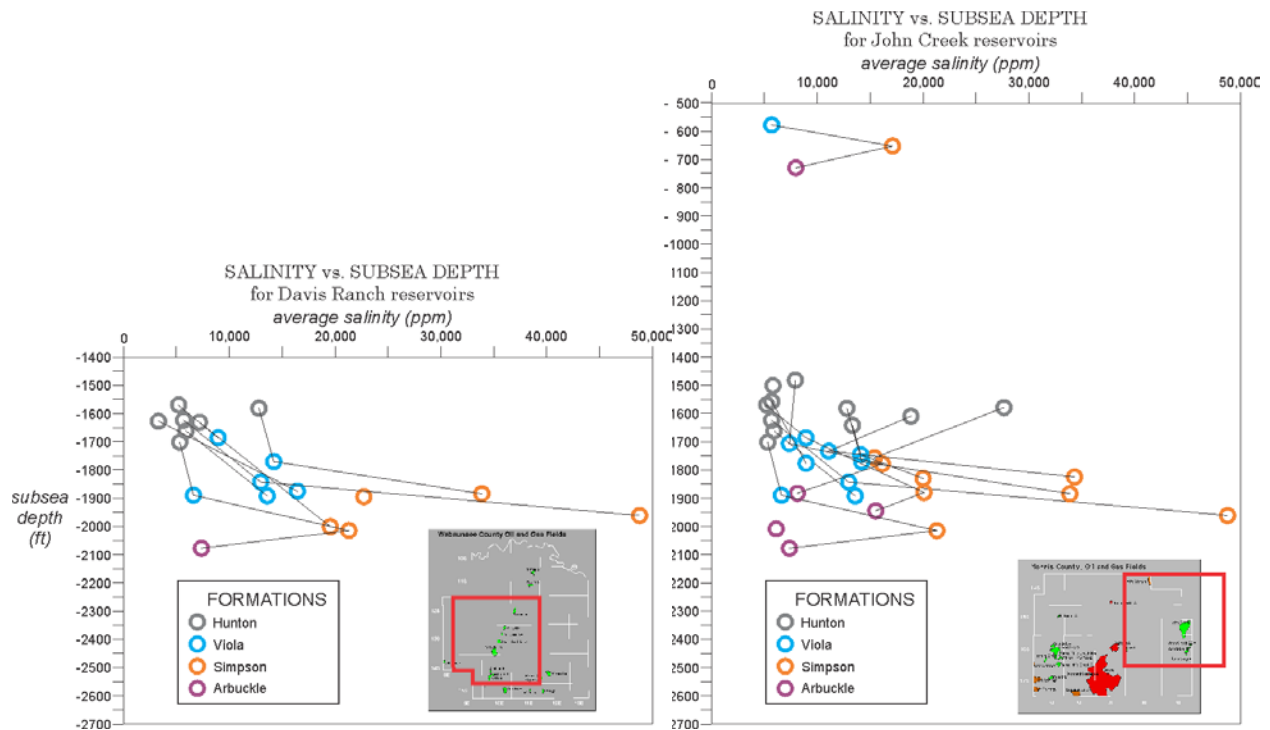

**Figure 13.** Bottom-hole pressure profiles for CO<sub>2</sub> injection.

**Geochemistry**

Geochemical analysis was deployed to verify the potential for seals above the target injections zones in the study area. The Forest City Basin is an oil producing region with traps contained by structures and vertical seals. Oil production in the two study fields is from the Kansas City Group, well above the Simpson, and the Viola, in close proximity above the Simpson. Although the Simpson Sandstone does not produce in either field, it does carry oil shows in the samples and is productive in nearby fields, indicating a vertical seal. The Arbuckle does not produce oil in the Forest City Basin.

Salinity data were gathered from the KGS online brine data base, chemical analysis of produced waters (from partner operators), DST recoveries, and by wireline log analysis by solving the Archie Equation for water saturation and converting it to salinity (Doveton, 2004). Salinity-depth crossplots in Figure 14 include all sources, except the Arbuckle analyses are only from the well-log resistivity method. The data show a distinct trend of gradual increase in salinity from the Hunton to Viola, a sharp steepening of the slope between the Viola and Simpson, and a sharp, distinct reversal between the Simpson and Arbuckle. The salinity data indicate the Simpson and Arbuckle are separate reservoirs (vertical seals) from each other and from overlying Viola and Hunton.



**Figure 14.** Salinity vs. depth plots for the Davis Ranch and John Creek fields. Lines connect dots from a common well.

**Goals and objectives for the next Quarter:**

- The plan is to complete an initial draft of high-level technical evaluations for the Pleasant Prairie site and one or two alternative sites.

**Products for Subtask 4.2:**

- Preliminary technical report for the Davis Ranch and John Creek fields in the Forest City Basin geologic complex (Appendix B).

**Subtask 4.3 - Compare results using NRAP with methods used in prior DOE contracts including regional and sub-basin CO<sub>2</sub> storage**

**Significant accomplishments:** Nothing to report.

**Plans for the next quarter:** Comparisons with NRAP tools is schedule for Project quarters 4 and 5.

**Subtask 4.4 - Develop an implementation plan and strategy for commercial-scale, safe and effective CO<sub>2</sub> storage**

**Significant accomplishments:** Nothing to report.

**Plans for the next quarter:**

Planning and strategy development may begin in the next quarter with most scheduled for Project quarter 3.

## References:

Bui, L. H., Tsau, J. S., and Willhite, G. P., 2010, Laboratory investigations of CO<sub>2</sub> near-miscible application in Arbuckle Reservoir: SPE Improved Oil Recovery Symposium held in Tulsa, Oklahoma, 24–28 April 2010, SPE Publication 129710.

Carter, R. D., and Tracy, G. W., 1960, An improved method for calculating water influx: Petroleum Transactions, AIME, vol. 219, p. 415–417.

Chang, K. W., Minkoff, S. E., and Bryant, S. L., 2009, Simplified model for CO<sub>2</sub> leakage and its attenuation due to geological structures: Energy Procedia, v. 1, p. 3,453–3460.

Dake, L. P., 1978, Fundamentals of Reservoir Engineering," Chapter 9, Elsevier Scientific Publishing Co., 1978.

Doveton, J.H., 2004, Applications of estimated formation water resistivities to brine stratigraphy in the Kansas subsurface: Kansas Geological Survey, Open-File report 2004-22, 20 p.

Watney, W.L. et al., 2015, Modeling CO<sub>2</sub> Sequestration in Saline Aquifer and Depleted Oil Reservoir to Evaluate Regional CO<sub>2</sub> Sequestration Potential of Ozark Plateau Aquifer System, South-Central Kansas, Final Report, Award Number: DE-FE0002056, submitted October 2, 2015, 4867 p.

Watney, W.L., 2016, Integrated CCS for Kansas (ICKan) SF 424 R&R, Application for Federal Assistance, Phase I - Integrated CCS Pre-Feasibility Study activity under CarbonSAFE, DOE-NETL FOA 1584.

Kansas Geological Survey, 2003, MidCarb CO<sub>2</sub> online property calculator, [http://www.kgs.ku.edu/Magellan/Midcarb/co2\\_prop.html](http://www.kgs.ku.edu/Magellan/Midcarb/co2_prop.html). Accessed on July 12, 2017.

## **Task 5.0 – Perform a high level technical CO<sub>2</sub> source assessment for capture**

### **Subtask 5.1- Review current technologies and CO<sub>2</sub> sources of team members and nearby sources using NATCARB, Global CO<sub>2</sub> Storage Portal, and KDM**

#### **Significant activities in the reporting period for Subtask 5.1:**

During the field trip to Westar's Energy Center and the CHS Inc. Refinery, the team had the opportunity to tour both facilities for a better understanding of the operations and the equipment onsite. The team discussed the physical conditions (volume, temperature, and pressure), space for capture equipment, and impact on plant operations. These conversations with the sites' operations personnel were beneficial in assessing the technical and economic feasibility for the installation of a carbon capture unit. Since the visit, there have been numerous follow up emails and calls to collect data of interest to the carbon capture process model. These include:

- a. Block flow diagram or layout of plant detailing unit operations
- b. Fuel characteristics
- c. Existing pre-treatment technologies for flue gas conditioning
- d. Flue gas composition
- e. Process conditions at various locations within the plant
- f. Sources and process conditions of steam available for Post-Combustion Capture (PCC)
- g. Cost of electricity/kWh (kilowatt-hour) and cost of steam

Options for techno-economic optimization of CO<sub>2</sub> capture were also discussed. The group identified locations of potential sources of excess heat within the plant that can reduce parasitic energy consumption, through recycle of these streams for use in the capture process.

**Significant accomplishments in the reporting period for Task 5.1:**

The key objective for this subtask, understanding the sources of CO<sub>2</sub> locations within the operation and physical conditions volume, temperature, and pressure, was accomplished for two of the three sources.

**CHS Inc. Refinery hydrogen reformers**

The refinery has advised the team to design a capture system for the current operating capacity of the plant (40 mmscfd and 42 mmscfd), despite the potential for future expansion or improvement projects. This is preferable since the reformers are not always run at 100% capacity at the same time. An initial mass and energy balance was obtained from CHS Inc. refinery for their two hydrogen reformers and is included in Table 8 for reference.

	<i>Stream</i>	<i>Syngas</i>	<i>Purge Gas</i>	<i>Flue Gas</i>
<b>#1 Hydrogen Reformer</b>	<i>Volume of CO<sub>2</sub>, %</i>	16.20	43.28	16.57
	<i>CO<sub>2</sub> Mass Flow, Tonnes/yr</i>	211	211	368.6
	<i>Total Flow, mmscfd</i>	67.87	25.4	115.9
	<i>Temperature, °F</i>	105	95	300
	<i>Pressure, psig</i>	380	4.5 +/- 2	~0
	<i>Composition</i> <i>CO(PPM)</i> <i>NOx(PPM)</i> <i>SOx (PPM)</i>	N/A	N/A	7.037 1.305* 5**
	<i>Stream</i>	<i>Syngas</i>	<i>Purge Gas</i>	<i>Flue Gas</i>
<b>#2 Hydrogen Reformer</b>	<i>Volume of CO<sub>2</sub>, %</i>	15.76	44.54	15.16
	<i>CO<sub>2</sub> Mass Flow, Tonnes/yr</i>	189.6	189.6	393.3
	<i>Total Flow, mmscfd</i>	62.67	22.17	135.1
	<i>Temperature, °F</i>	105	95	300
	<i>Pressure, psig</i>	373	5 +/- 2	~0
	<i>Composition</i> <i>CO(PPM)</i> <i>NOx(PPM)</i> <i>SOx (PPM)</i>	N/A	N/A	0.04 lb/MMBtu*** 33.28 5**

\* Reformer Unit#1 is fitted with SCR (selective catalytic reduction) for NOx reduction

\*\*Value not monitored. May be a construction value

\*\*\*Construction value

**Table 8.** Mass and Energy Balance for hydrogen reformers at CHS Inc. Refinery. Abbreviations include mmscfd – million standard cubic feet/day, °F – degrees Fahrenheit, psig – pounds per square inch gauge, ppm – parts per million, CO – carbon monoxide, NOx – nitrogen oxides, SOx – sulfur oxides, lb/MMBTU – pounds per million British Thermal Units.

**Westar Energy Company’s Jeffrey’s Energy Center:**

Figure 15 is generic block diagram of a sub-critical pulverized coal power plant similar to the units at

Westar Energy Company. This block diagram also incorporates a block for the post-combustion capture plant which takes the flue gas and steam from the power plant and returns the condensate to the steam system and the CO<sub>2</sub> depleted flue gas to the stack. Annotations on this figure highlight three opportunities to access sources of currently unutilized heat in the Westar Energy Center's power plant process that could be used to generate steam for reclamation of the solvent in the stripper.

- a. The flue gas leaving the Induced Draft (ID) fan is around 350-400°F and goes to the FGD (flue gas desulfurizer) which operates at around 100°F.
- b. The high temperature (~600-700°F) flue gas after nitrogen oxide (NO<sub>x</sub>) removal is cooled to ~350-400°C in the power plant process prior to the next unit, which is an activated carbon based sorbent system for mercury and other metal contaminant removal.  
Heat recovery may be possible from the ash removal hopper as the solids leaving the boiler enter this hopper at a high temperature.

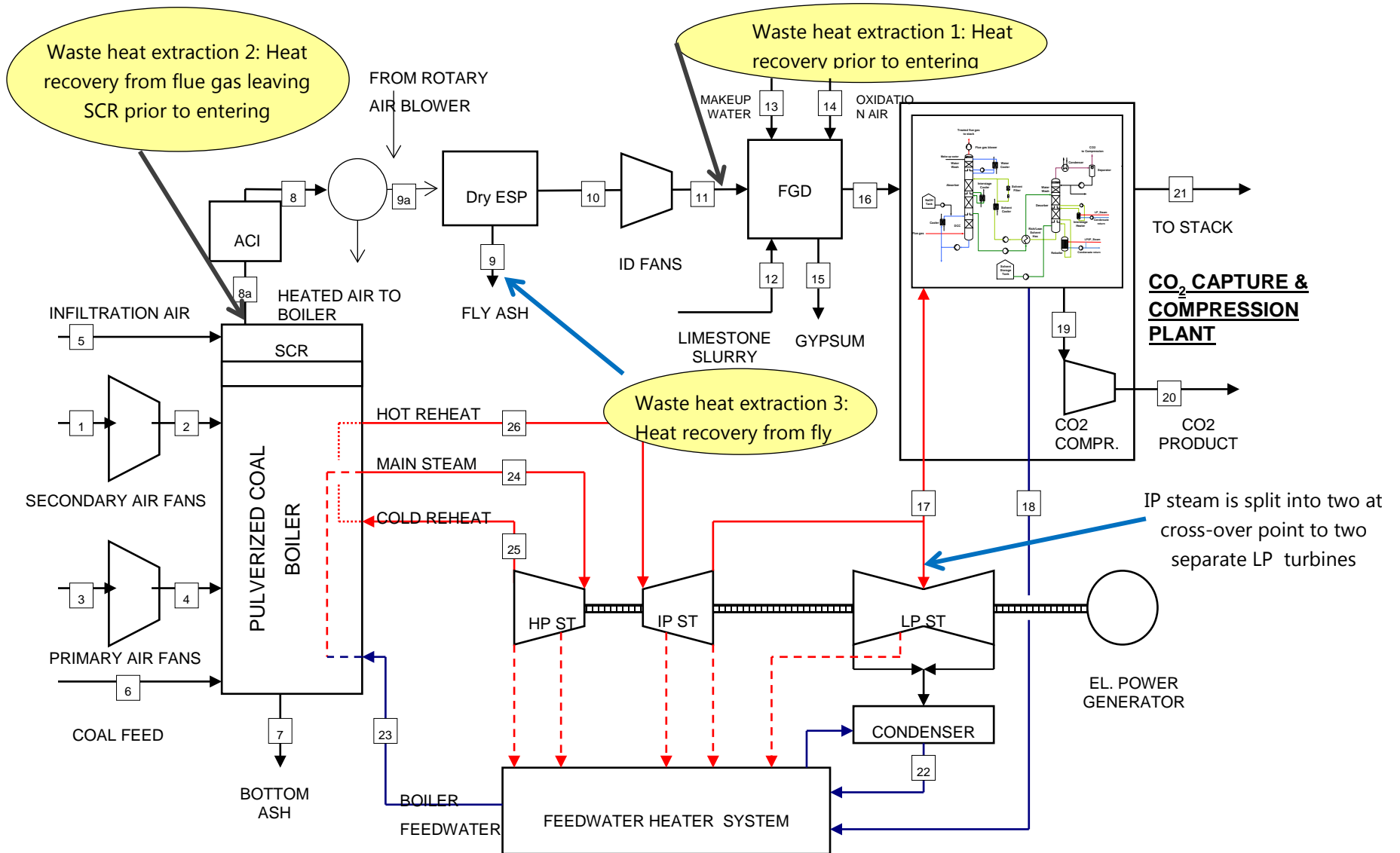

**Figure 15.** Block Flow Diagram of power plant showing potential sources of waste heat for extraction and use in PCC plant to generate low pressure steam



## Subtask 5.2- Determine novel technologies or approaches for CO<sub>2</sub> capture

### Significant activities in the reporting period for Subtask 5.2:

The Linde team reviewed their portfolio of technology options for CO<sub>2</sub> capture that could potentially be installed at either of the two sites under consideration.

### Significant findings in the reporting period for Task 5.2:

Solvent based technologies for post-combustion capture are the leading candidates for large-scale capture and would be the most likely option at the **Westar Energy Center**. The Linde-BASF novel amine-based technology for post combustion capture removes more than 90% of the CO<sub>2</sub> from all or part of the flue gas (Krishnamurthy, 2016). With the successful completion of the pilot campaign at the National Carbon Capture Center (NCCC) in 2016, the Linde-BASF system has achieved a Technology Readiness Level (TRL) of 6 (U.S. Department of Energy, 2012), and demonstrated significant improvements to the performance, efficiency and the cost of electricity when compared to today's state of the art capture systems (see Process Flow Diagram in Figure 16), Bostic et al., 2017.

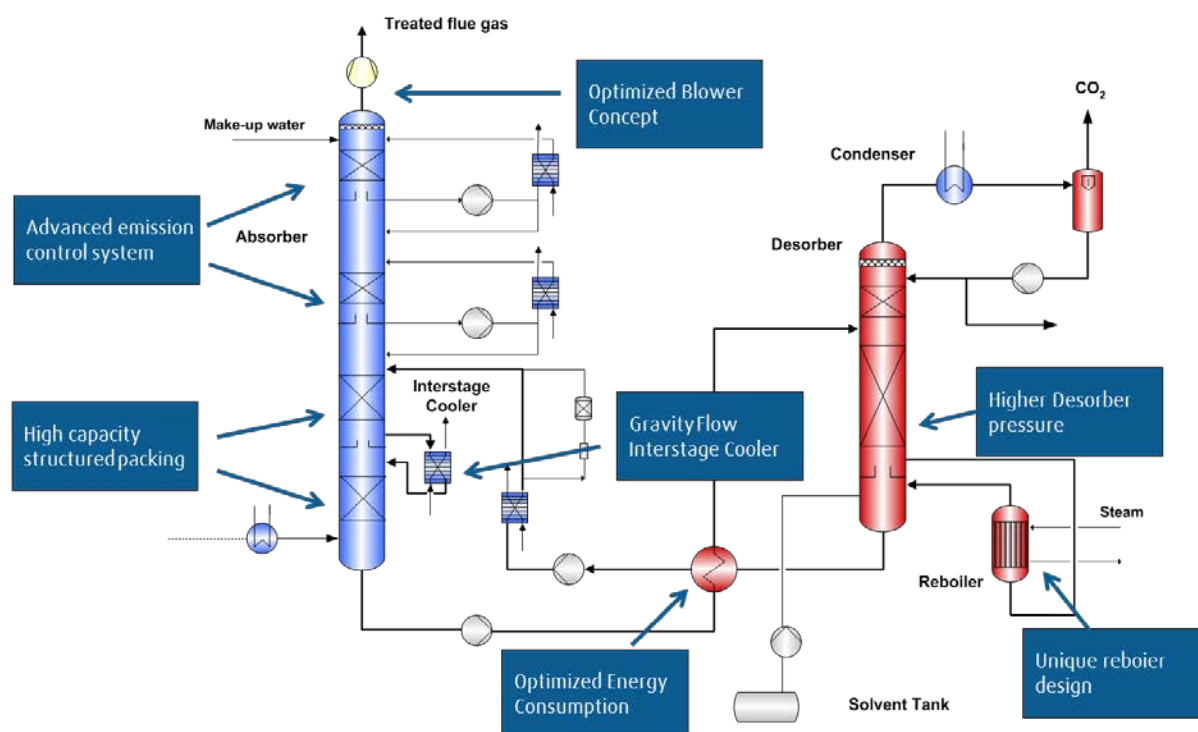

**Figure 16:** Linde-BASF novel amine-based PCC technology: Optimized for reduced parasitic energy need and low capital expenditures (from Krishnamurthy, 2016).

Options for industrial CO<sub>2</sub> capture at the **CHS Refinery SMR-based hydrogen reformers** can be either solvent-based, sorbent-based or membrane applications. Solvent based post-combustion capture from the reformer furnace flue gas will result in maximum CO<sub>2</sub> emissions reduction (~90% of total emissions from SMR H<sub>2</sub> plants (Krishnamurthy, 2017). Sorbent based (pressure or vacuum swing adsorption – PSA, VSA) capture from syngas or purge gas are likely technology options for partial capture (~50-60% of total SMR

H<sub>2</sub> plant emissions) as they are more cost effective than solvent based due to relatively smaller capture capacity (Krishnamurthy, 2017). Figure 17 shows three potential configurations for carbon capture from the reformer.

1. Process side from H<sub>2</sub> PSA purge gas: Low pressure, higher CO<sub>2</sub> concentration: PSA/VSA, FlashCO<sub>2</sub>, Membranes. Power requirements of 280 kWh/t CO<sub>2</sub> (kilowatt-hour/ton CO<sub>2</sub>) captured
2. Combustion side (furnace; 100%): Low pressure, low concentration – Solvent based. Power requirements of 130 kWh/t CO<sub>2</sub> captured. Steam requirements of 1.2 – 1.3 t/t CO<sub>2</sub> (ton/ton CO<sub>2</sub>) captured
3. Process side CO<sub>2</sub> removal from syngas (~60-70%): Medium pressure, low CO<sub>2</sub> concentration – applicable technologies include solvents, PSA/VSA and integrated membrane.

Based on the relative costs of steam and electricity at the refinery, as well as the capital requirements of a potential new gas fired boiler, a determination will be made of the best fit technology. The current cost of electricity at the refinery is \$0.04425/KWH. The estimated cost for a new boiler is still to be determined.

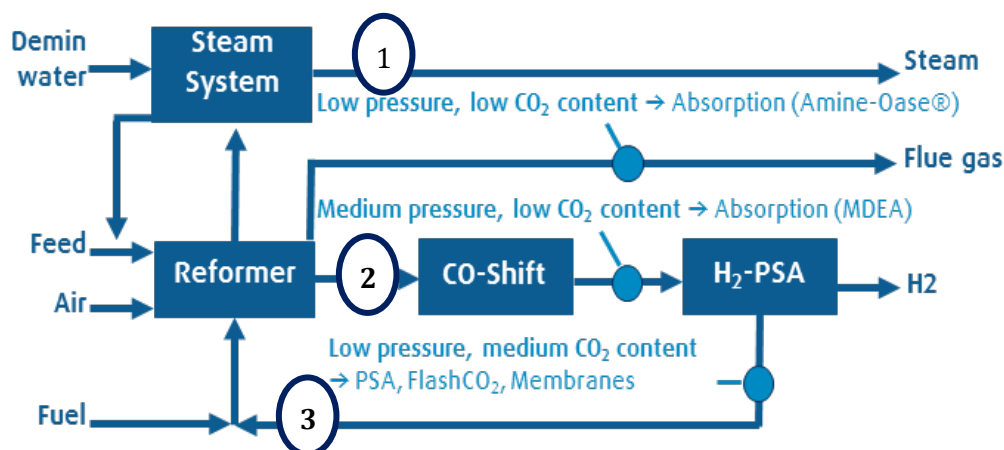

**Figure 17:** CO<sub>2</sub> Capture in Steam-methane reformer (SMR) based H<sub>2</sub> plants: Solvent, PSA/VSA & membrane applications

### Subtask 5.3- Develop an implementation plan and strategy for cost effective and reliable carbon capture

#### Significant activities in the reporting period for Subtask 5.3:

The information gathered from discussions and emails with the operations personnel at both sites was shared with the Linde engineering team. A proposal for the conceptual development of a post combustion carbon capture plant, including CO<sub>2</sub> compression and drying was completed and the scope of work, costs and timeline for the activity was defined. The feasibility study will consider the following two sources:

- Source 1: coal fired power plant, Westar Energy Company's Jeffery Energy Center, St. Marys, KS
- Source 2: flue gas from 2 SMR (combined PCC), CHS Inc.'s Refinery, McPherson, KS.

For both sources, the study will develop the following deliverables:

- Process Flow Diagram (PFD)
- Overall material balance (block flow diagram level)

- Utility consumption
- CAPEX (+/- 40%)
- Plot space requirement

The estimated timeline for this activity shall be eight weeks after receipt of all flue gas composition, available utility information and CO<sub>2</sub> product specification from the operations staff at Westar Energy Center and CHS Refinery.

**Goals and objectives for the next Quarter for Task 5:**

- Complete the preliminary design of post combustion carbon capture plants for Jeffrey Energy Center and CHS Refinery.
- Share the preliminary design with Westar Energy Center and CHS Refinery, evaluate from operations perspective, and consider plan modifications.
- Investigate alternatives for optimization opportunities identified in Subtask 3.1, heat capture to be used for steam generation at Jeffrey Energy Center and steam management options at the CHS Refinery.

**Products for Task 5:**

- Characterization of CO<sub>2</sub> stream from the CHS Refinery reformers in table format.
- Characterization of CO<sub>2</sub> stream from the Jeffrey Energy Center 800 MWe coal-fired generators in text format.
- Flow diagram for Jeffrey Energy Center illustrating potential waste heat sources and location for CO<sub>2</sub> capture facilities.

**References**

Bostick, D., T. Stoffregen and S. Rigby, 2017, Final Techno-Economic Analysis of 550 MWe Supercritical PC Power Plant CO<sub>2</sub> Capture with Linde-BASF Advanced PCC Technology, USDOE Office of Fossil Energy, Clean Coal and Carbon. Accessed 6/27/2017.

Krishnamurthy, K.R., 2016, Slipstream pilot plant demonstration of an amine based post-combustion capture technology for CO<sub>2</sub> capture from coal-fired power plant flue gas, 2016 NETL CO<sub>2</sub> Capture Technology Meeting. August 8-12, 2016. <https://www.netl.doe.gov/File%20Library/Events/2016/c02%20cap%20review/2-Tuesday/K-Krishnamurthy-Linde-Amine-Based-Process-Technology.pdf> Accessed 6/27/2017.

Krishnamurthy, K.R., 2017, Linde carbon capture technologies for power and SMR based H<sub>2</sub> plants: Development & commercialization and Techno-economic assessment. Integrated CCS for Kansas (ICKan) Kick-off Meeting. February 14, 2017.

U.S. Department of Energy, 2012, 2012 Technology Readiness Assessment Overview, Clean Coal

Research Program, U.S. Department of Energy, Office of Fossil Energy. [https://www.netl.doe.gov/File%20Library/Research/Coal/energy%20systems/gasification/TRA-Overview-Report\\_121112\\_FINAL\\_1.pdf](https://www.netl.doe.gov/File%20Library/Research/Coal/energy%20systems/gasification/TRA-Overview-Report_121112_FINAL_1.pdf) Accessed 6/27/2017.

## **Task 6.0 – Perform a high level technical assessment for CO<sub>2</sub> transportation**

### **Subtask 6.1 - Review current technologies for CO<sub>2</sub> transportation**

See non-technical challenges to pipeline transportation, possible solutions to challenges, and plans for implementation in Subtask 3.2.

### **Subtask 6.2- Determine novel technologies or approaches for CO<sub>2</sub> transportation**

Nothing to report.

### **Subtask 6.3 - Develop a plan for cost-efficient and secure transportation infrastructure**

#### **Overview:**

Understanding the economics of and exploring options and strategies to transport CO<sub>2</sub> from large-scale anthropogenic sources, in particular coal-fired power plants, in the most optimal manner is a key component of the ICKan project. Estimating cost for variety of pipeline scenarios is the first step in the process. Because large-scale coal-fired power plants (e.g.: Jeffrey Energy Center) are distant to potential storage sites, pipelines are the only option for transporting large volumes of CO<sub>2</sub>. However, pipelines have extremely high capital costs that negatively impact the overall costs and feasibility for CCS projects. The ICKan project considers the option of reducing the net costs for CO<sub>2</sub> transported for CCS by combining CO<sub>2</sub> captured from power plants and/or a refinery with CO<sub>2</sub> destined for EOR operations. One case would include a very large-scale system where CO<sub>2</sub> is captured from 32 ethanol plants in the Upper Midwest and joined with CO<sub>2</sub> captured from a power plant (Westar's Jeffrey Energy Center). CO<sub>2</sub> would then be transported to a saline aquifer storage site as well as to EOR markets. Both sides would benefit by the economies of scale for the pipeline system. Another case considered (without the ethanol CO<sub>2</sub> component) is for the capture be scaled large enough to sell CO<sub>2</sub> for EOR, again gaining the benefits from scale and possible from revenues generated by the sale of CO<sub>2</sub> for EOR.

#### **Summary of significant activities:**

- Performed an extensive review of literature on CO<sub>2</sub> pipeline transportation modeling and whitepapers on the development of CO<sub>2</sub> pipeline infrastructure.
- Researched and tested the FE/NETL CO<sub>2</sub> Transport Cost Model, an excel-based (spreadsheet formulas and Excel Visual Basic for Applications (VBA)) for estimating costs and other financial projections for CO<sub>2</sub> pipelines. Cost model results were compared with an independent private pipeline engineering study and found to have comparable results.
- Modified the FE/NETL CO<sub>2</sub> Transport Cost Model (Grant et al., 2013, and Grant and Morgan, 2014) to meet the ICKan project's needs by adding more Excel VBA macro functionality. The enhanced model was used to estimate equipment required, and capital and operating costs for four, multi-segment pipeline scenarios.
- Established collaboration with Eric Mork, EBR Development LLC (EBR), for evaluating large-scale capture, compression and transportation systems for CO<sub>2</sub> from ethanol plants in the Midwest.

#### **Significant Results/Key Outcomes:**

**Key outcome 1**

ICKan project established a collaborative relationship with Eric Mork (EBR) to evaluate potential for capture, compression and transportation of CO<sub>2</sub> from Upper Midwest ethanol plants to markets for CO<sub>2</sub> EOR in Kansas, Oklahoma and Texas. Mork has extensive experience in the ethanol business, is well connected throughout and has contacted the owners of more than forty ethanol plants regarding the concept. The pipeline system would connect with the present day CO<sub>2</sub> pipeline infrastructure in West Texas. Ethanol CO<sub>2</sub> could also be stored long term in saline aquifers under the right economic conditions. Such a pipeline could also carry CO<sub>2</sub> from industry partners in the ICKan project, Jeffrey Energy Center, Holcomb Station and CHS Refinery, to saline aquifer storage sites, possibly reducing costs to the CCS project.

**Key outcome 2:**

Successfully modified the Transport Cost Model, designed to model a single segment of pipeline, to one that models multiple segments of a complex gathering and transportation system in one operation. With seven simple inputs for each segment the model outputs 14 parameters including pipe diameter, capital costs and annual operating expenses, by segment, in a Table 1. Distance used for each segment was 1.2 times the straight-line distance between the points to account for deviations in the path in an actual pipeline system. Model modifications and its application is more fully described in Appendix C.

**Inputs (by segment)**

length (miles)  
 number of booster pumps  
 annual CO<sub>2</sub> transport capacity (MT/yr)  
 capacity factor  
 input pressure (psig)  
 output pressure (psig)  
 change in elevation (feet)

**Outputs (by segment)**

minimum pipeline ID (inches)  
 pipeline nominal diameter (inches)  
 materials costs  
 labor costs  
 ROW-damage costs  
 miscellaneous costs  
 CO<sub>2</sub> surge tanks costs  
 pipeline control system costs  
 pump costs  
**Total capital cost**  
 pipeline O&M  
 other equipment and pumps O&M  
 electricity costs for pumps  
**Total annual operating expenses**

**Table 9:** Model inputs and outputs. Abbreviations include: MT/yr – million tonnes/year, psig – pounds per square inch gauge, ID – inside diameter, ROW – right of way, O&M – operations and maintenance.

**Key outcome 3:**

In an initial analysis, defined equipment required and estimated capital and operating costs for four separate pipeline scenarios using the modified Transport Cost Model. Geospatial relationships for the separate systems are illustrated in Figures 18-21, and statistics and costs are tabulated in Tables 10 and 11.

1. Jeffery & CHS + Ethanol to storage and EOR market: CO<sub>2</sub> from 32 ethanol plants, most having been contacted by EBR, plus CO<sub>2</sub> from Westar's Jeffrey Energy Center transported to Pleasant Prairie saline aquifer storage site and the majority to EOR markets. Approximately 1867 miles of pipeline would gather and transport 13.44 million tonnes of CO<sub>2</sub> per year (MT/yr), 10.94 from 32 ethanol sources and 2.5 from Jeffery.
2. Jeffery to nearby storage: 2.5 MT/yr CO<sub>2</sub> from Westar's Jeffrey Energy Center transported in 51 miles of pipeline to the Davis Ranch and John Creek oil fields for saline aquifer storage.
3. Jeffery + CHS to distant storage: 2.5 MT/yr CO<sub>2</sub> from Westar's Jeffrey Energy Center and 0.75 MT/yr CO<sub>2</sub> from CHS refinery transported on pipelines covering 353 miles to the Pleasant Prairie field for saline aquifer storage.
4. Jeffery to distant storage: 2.5 MT/yr CO<sub>2</sub> from Westar's Jeffrey Energy Center transported in 353 miles of pipeline to the Pleasant Prairie oil field for saline aquifer storage.

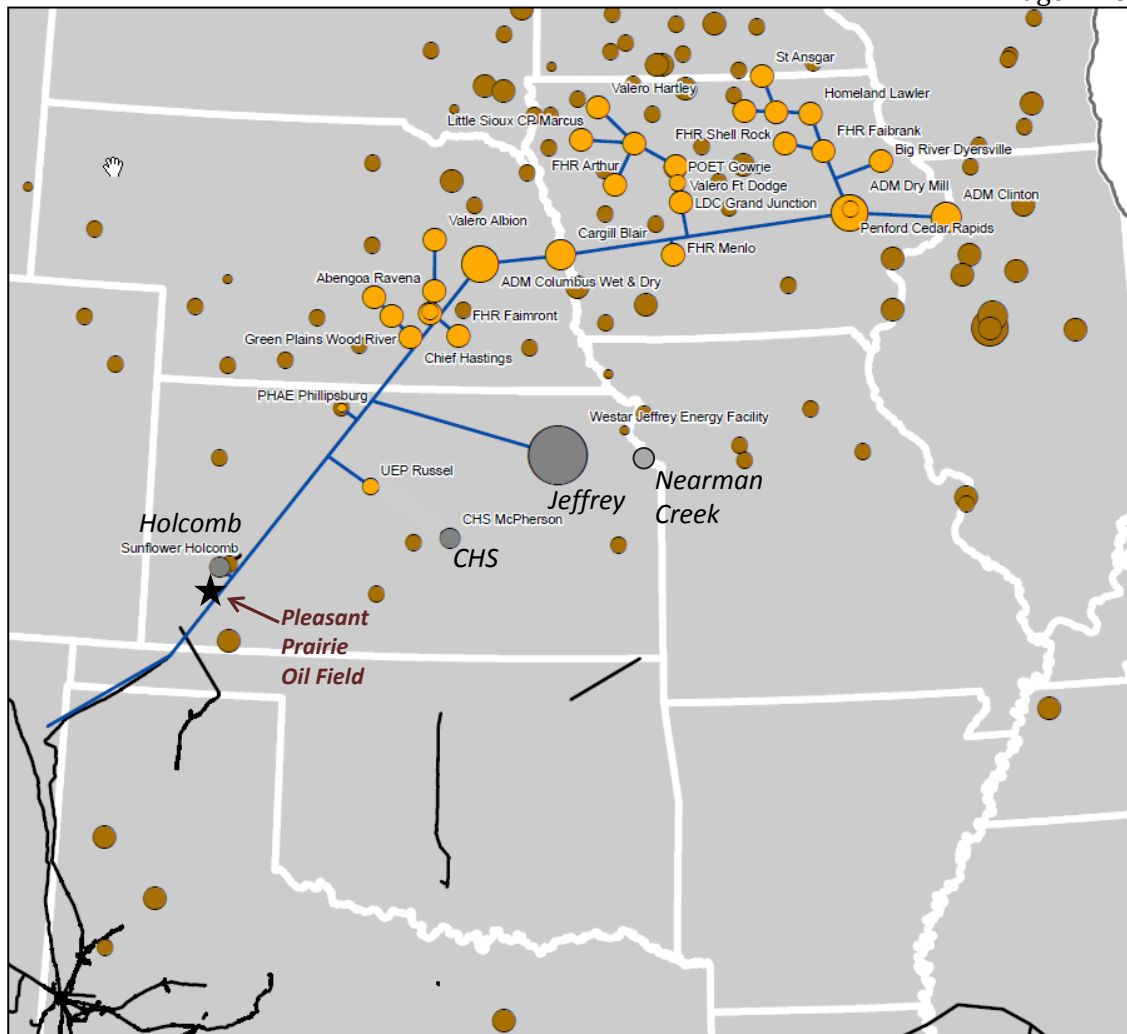

**Figure 18.** Pipeline Scenario 1, connecting 32 ethanol plants and delivering CO<sub>2</sub> to Kansas, Oklahoma and Texas. Bubbles are sized according to CO<sub>2</sub> volume. Ethanol plants are yellow (in the evaluated scenario) and brown (not in the scenario). Gray circles are ICKan industry partners, one of which is shown to be connected under this scenario. Pleasant Prairie is one of the storage sites considered in the project. Black line segments are existing CO<sub>2</sub> pipeline infrastructure.

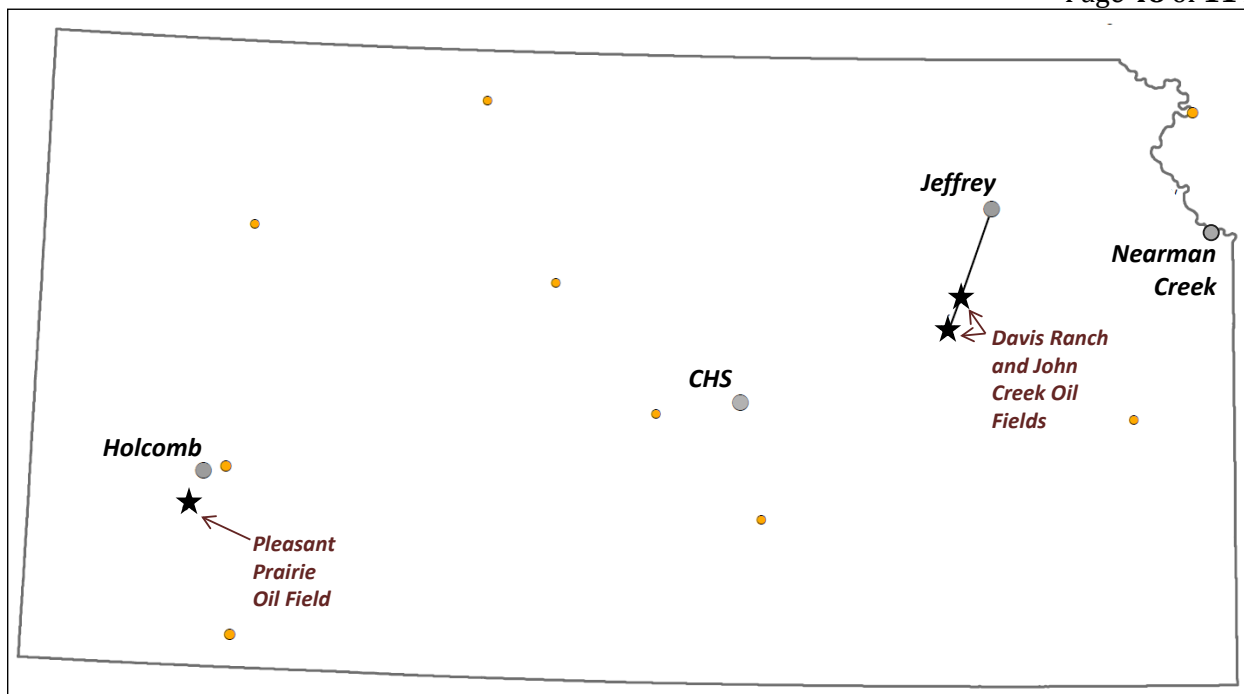

**Figure 19.** Pipeline Scenario 2, connecting Westar’s Jeffrey Energy Center to Davis Ranch and John Creek oil fields. Potential CO2 sources include ICKan industry partners (gray circles) and ethanol plants (yellow circles). Possible saline aquifer storage sites are beneath oil fields.

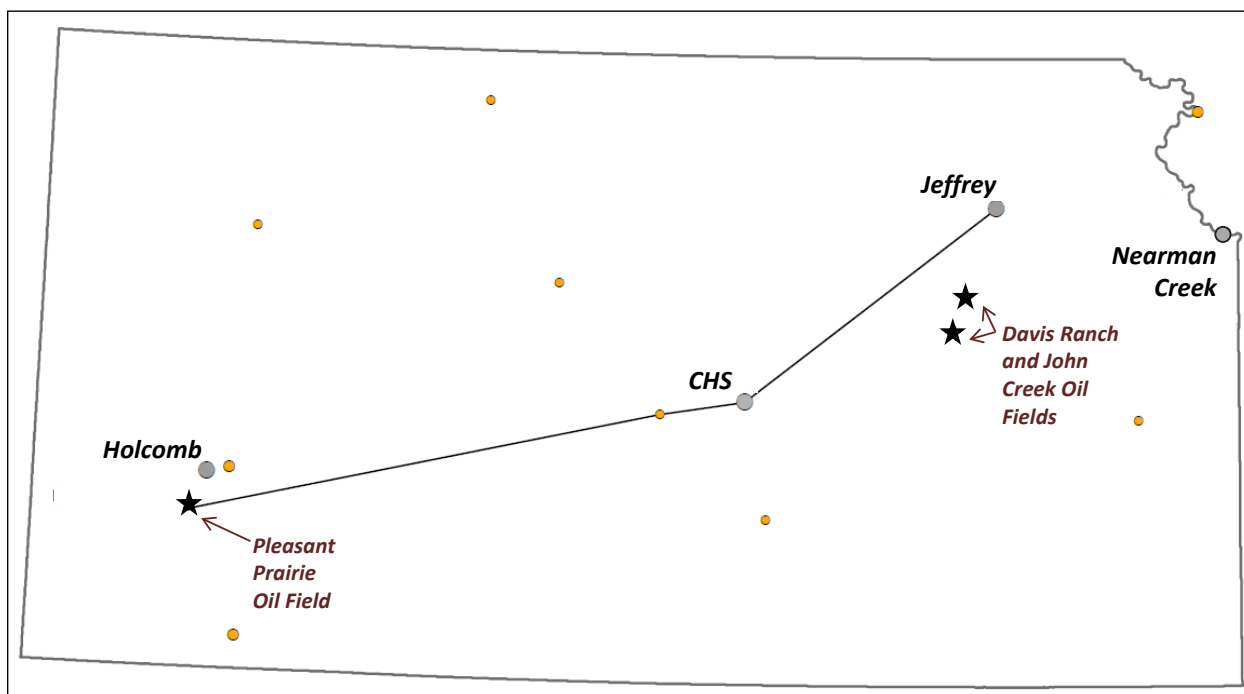

**Figure 20.** Pipeline Scenarios 3 and 4. Scenario 3 connects Westar’s Jeffrey Energy Center the CHS Refinery and then to the Pleasant Prairie oil field. Potential CO2 sources include ICKan industry partners (gray circles) and ethanol plants (yellow circles). Possible saline aquifer storage sites are beneath oil fields.



Number of Segments	32
Distance X 1.2 (mi)	1,867
CO2 Volume (Mtonnes/yr)	13.44
Pipeline sizes (in)	4" to 24"
Booster Station Count	75
NETL Model CapX (\$M)	\$2,254
NETL Model OpX/yr (\$M)	\$76.5
*Additional Pump Station Count	32
*Additional Pump CapX (\$M)	\$46
*Additional Pump OpX (\$M/yr)	\$23.3
Total Capital Costs (\$M)	\$2,300
Total Operating Costs (\$M/yr)	\$99.8

**Table 10.** Scenario 1 gathering and transportation system summary statistics, and capital and operating costs. \*NETL cost model does not account for additional pump stations where segments join. Costs are estimated by ICKan team.

	Scenario No.	Distance (mi)	Distance (mi) X 1.2	Volume (MT/yr)	Size (inches)	CapX (\$Million)	Annual OpX (\$Million)
Jeffrey EC to MidCon Trunk	part of 1	151	181	2.5	12"	\$164	\$3.8
Jeffrey EC to Davis Ranch and John Creek	2	42	51	2.5*	12" & 8"	\$47	\$1.3
Jeffrey EC to CHS and Pleasant Prairie	3	294	353	3.25**	12"	\$323	\$8.0
Jeffrey EC to Pleasant Prairie	4	294	353	2.5	12"	\$322	\$7.2

**Table 11.** Scenarios 2, 3, and 4 gathering and transportation system summary statistics, and capital and operating costs. Jeffery to main trunk line segment is also included.

## Discussion

ICKan industry partners' CO2 volumes emitted on an annual basis and the estimated portion that could reasonably be available to the CCS project are shown in Table 12. Jeffrey Energy Center and CHS refinery volumes are discussed in this quarterly report on Task 5. Dearman Creek volume is from the plant operator and Holcomb Station is estimated by plant size. Ethanol plant CO2 volumes were calculated based on gallons/yr ethanol output from the latest EIA-819M Monthly Oxygenate Report (U.S. DOE, 2017), converted to CO2 output at the rate of 6.624 lbs. CO2/gallon ethanol (Dubois et al., 2002).

	Mwe	Approx. CO2 Emitted (MT/yr)	Est. Vol. Available (MT/yr)
Jeffrey Energy Center	2400	12.5	2.5
Dearman Creek	261	1.2	?
Holcomb Station	350	1.8	?
CHS refinery	NA	1.4	0.76

**Table 12.** Industry partner CO2 source data. Abbreviations include Mwe – megawatt electric and MT/yr – million tonnes/year.

Although economics were not analyzed at this stage of the investigation, capital and operating costs, excluding interest and business margin, are easily calculated relative to the volume of CO2 delivered. Assuming a 20-year operating life and costs from the model outputs for Scenario 1, capital costs are \$8.56/tonne (\$0.45/mcf), operating costs are \$7.43/tonne (\$0.39/mcf), and total costs (\$15.98/tonne (\$0.84/mcf)).

**Goals and objectives for the next Quarter:**

- Continued refinement in the CO2 Transport Cost Model, including, where possible, updating the cost variables from 2011 (current model) to present day costs.
- Utilize CO2 Transport Cost Model to analyze transport economics under varying pipeline configurations and financial scenarios.
- Modify pipeline scenarios, volumes and locations of lines, as needed depending on outcomes from CO2 source and geologic storage site studies.
- Consider other optimization opportunities, such as shared ROW to reduce costs.

**Products for Subtask 6.3:**

- Modifications to the FE/NETL CO2 Transport Cost Model to better fit the ICKan project needs (More fully described in Appendix C).
- Equipment specified and costs estimates for four possible pipeline transportation scenarios. (More fully described in Appendix C).

**References:**

Dubois, M. K., S. W. White, and T. R. Carr, Co-generation, 2002, Ethanol Production and CO2 Enhanced Oil Recovery: a Model for Environmentally and Economically Sound Linked Energy Systems: Proceedings 2002 AAPG Annual Meeting, Houston, Texas, p. A46. Kansas Geological Survey Open-file Report 2002-6. <http://www.kgs.ku.edu/PRS/Poster/2002/2002-6/index.html> Accessed 7/1/2017.

Grant, T., D. Morgan, and K. Gerdes, 2013, Carbon Dioxide Transport and Storage Costs in NETL Studies: Quality Guidelines for Energy Systems Studies: DOE/NETL-2013/1614, 22 p.

Grant, T. and D. Morgan, 2014, FE/NETL CO2 Transport Cost Model. National Energy Technology Laboratory. DOE/NETL-2014/1667. <https://www.netl.doe.gov/research/energy-analysis/analytical-tools-and-data/co2-transport>. Accessed 6/28/2017.

US Dept. of Energy, Energy Information Administration, 2017, Ethanol Plans (EIA-819M Monthly Oxygenate Report, March 27, 2017. [https://www.eia.gov/maps/layer\\_info-m.php](https://www.eia.gov/maps/layer_info-m.php) Accessed June 1, 2017.

## **Task 7.0 – Technology Transfer**

The ICKan project decided on 2 areas for consideration for the CO<sub>2</sub> sequestration, the Forest City Basin which includes the John Creek & Davis Ranch Fields and the Pleasant Prairie Field. A search area was created to search for wells and the available data in the Kansas Geological Survey Database. A web page was created so the project members could get direct access to the wells in the study areas. The web page URL is <http://www.kgs.ku.edu/PRS/ICKan/Summary/> and is illustrated in the following sections.

### **Subtask 7.1- Maintain website on KGS server to facilitate effective and efficient interaction of the team**

The ICKan Project Well Data Summary Web Page provides a publicly available database for users to view and download data collected from the ICKan project. This page is updated on a regular basis and maintained by John Victorine with contributions from others. A screenshot of the well data summary page is provided below in figure 20.



## ICKan Project



### Carbon Storage Assurance Facility Enterprise (CarbonSAFE)

### Well Data Summary Page

Work is partially supported by the U.S. Department of Energy (DOE) National Energy Technology Laboratory (NETL) under Grant Number DOE-NETL FOA 1584 titled, Carbon Storage Assurance Facility Enterprise.

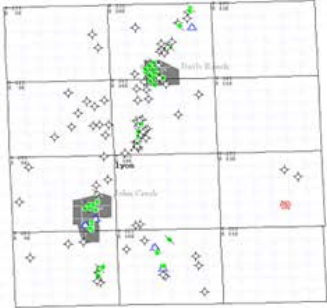
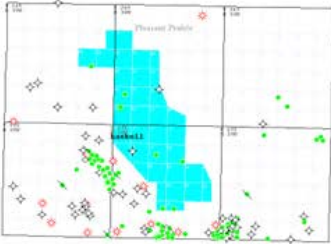
You will need a Java Runtime Environment (JRE) on your PC to run the web app on your pc. Go to <http://java.com> to download the latest version.

Java Well Map Applets	
Forest City Basin	Pleasant Prairie Field
	
<p><b>Search Criteria:</b></p> <ul style="list-style-type: none"> <li>Rotary Total Depth greater than 2800 feet</li> <li>Township &amp; Range from T13 S to T16 S &amp; R9 E to R11 E</li> </ul>	<p><b>Search Criteria:</b></p> <ul style="list-style-type: none"> <li>Rotary Total Depth greater than 5500 feet</li> <li>Township &amp; Range from T26 S to T 27 S &amp; R33 W to R35 W</li> </ul>
<p>Select either of the map images above to view the Well Data Map Applet.</p> <p><b>NOTE: Google Chrome does NOT support Java.</b></p>	
Download the Java Well Map Program to your PC and Run it as an Application	
<p>Presently the supporting download only supports Windows Environment.</p> <p>Installation</p> <ol style="list-style-type: none"> <li>1. You will need a Java Runtime Environment (JRE) on your PC to run the web app on your pc. Go to <a href="http://java.com">http://java.com</a> to download the latest version.</li> <li>2. Download ICKan-MapWells zip to your PC <a href="http://www.kgs.ku.edu/PRS/ICKan/software/MAP/ICKan-MapWells.zip">http://www.kgs.ku.edu/PRS/ICKan/software/MAP/ICKan-MapWells.zip</a></li> <li>3. Unzip the file. The program files are located under a directory called 'ICKan-MapWells' so it is safe to unzip where ever you like.</li> <li>4. Run either Well Map Area Java Application. On Windows, simply run 'Run_FCB.bat' or 'Run_PiPr.bat' in the ICKan-MapWells directory</li> </ol> <p style="font-size: x-small;">double click on 'Run_FCB.bat script' to run the Map for the Forest City Basin double click on 'Run_PiPr.bat script' to run the Map for the Pleasant Prairie.</p>	
Well Data Summary Web Pages	
Forest City Basin	Pleasant Prairie Field
<ul style="list-style-type: none"> <li>for All Wells</li> <li>for Wells with ELOG Image Files</li> <li>for Wells with Log ASCII Standard (LAS) 2.0 Files</li> <li>for Wells with Drill Stem Test (DST) Files</li> <li>for Wells with Core Data Files</li> </ul>	<ul style="list-style-type: none"> <li>for All Wells</li> <li>for Wells with ELOG Image Files</li> <li>for Wells with Log ASCII Standard (LAS) 2.0</li> <li>for Wells with Drill Stem Test (DST) Files</li> <li>for Wells with Core Data Files</li> </ul>
<p><b>Search Criteria:</b></p> <ul style="list-style-type: none"> <li>Rotary Total Depth greater than 2800 feet</li> <li>Township &amp; Range from T13 S to T16 S &amp; R9 E to R11 E</li> </ul>	<p><b>Search Criteria:</b></p> <ul style="list-style-type: none"> <li>Rotary Total Depth greater than 5500 feet</li> <li>Township &amp; Range from T26 S to T 27 S &amp; R33 W to R35 W</li> </ul>
<p>This page created February 2017 Comments to <a href="mailto:jvictor@kgs.ku.edu">jvictor@kgs.ku.edu</a> The URL for this page is <a href="http://www.kgs.ku.edu/PRS/ICKan/Summary/index.html">http://www.kgs.ku.edu/PRS/ICKan/Summary/index.html</a></p>	

**Figure 21.** ICKan Project Well Summary page.

There are three sections to this web page. The first two represent two versions of the Well Map Web app, an applet that can be run from the summary web page and an application that can be downloaded to the user's PC. The Web applet can be run by clicking on the top two maps, Forest City Basin on the left and Pleasant Prairie Field on the right. The Java program that was created is the same for both areas, but there is a switch within the program that will retrieve the correct data set from the Kansas Geological Survey Database depending on the area of interest. The Java Well Map web app will map all wells that match the search criteria for each well, e.g.

Forest City Basin

- Rotary Total Depth greater than 2800 feet
- Township & Range from T13 S to T16 S & R9 E to R11 E

Pleasant Prairie

- Rotary Total Depth greater than 5500 feet
- Township & Range from T26 S to T 27 S & R33 W to R35 W

Clicking on the Forest City Basin will display the Forest City Basin area with the Davis Ranch & John Creek Fields in gray with the available wells displayed with the above township / range area, see image below,

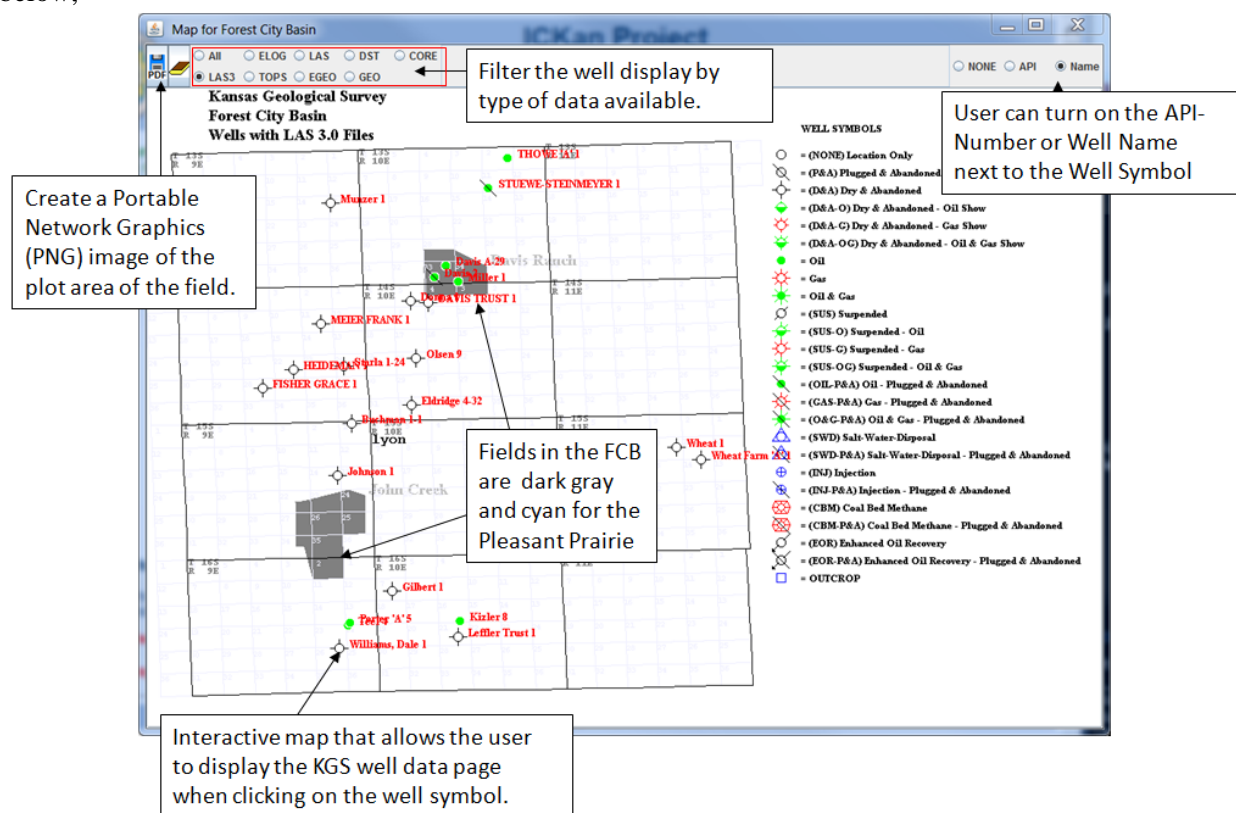

**Figure 22.** Example of the Forest City Basin data page.

The image map is an interactive map that allows the user to view the available wells and their data in relation to the fields. The user can move the cursor over any of the and the well name and api-number will be displayed at the top center. The user can also click on the well to open the Kansas Geological Survey (KGS) well data page for the selected well. This page holds all the data that is in the KGS database and file server. The wells are plotted by well symbols with the well symbol legend displayed in the right hand side of the plot. The top panel allows the user the following controls:

Create a Portable Network Graphic (PNG) image of the plot that is displayed by clicking on the  button icon image. The radio buttons immediately to the right of the icon buttons are data type filters. The map will display the data type that is selected, i.e.

- All - shows all the wells that fit the above search criteria for the specific field.
- ELOG - Shows wells with well log image files
- LAS - Shows wells with Log ASCII Standard (LAS) version 2.0 files
- DST - Shows wells with Drill Stem Test (DST) files
- CORE - Shows wells with Measured Core Data files
- LAS3 - Shows wells with Log ASCII Standard (LAS) version 3.0 files
- TOPS - Shows wells of the tops that are in the “Qualified - Well Tops” or the “CO2 - Well Tops” database tables.
- EGEO - Shows wells with geologist cuttings report & core description image files.
- GEO - Shows wells with geologist cuttings report as ASCII files (cuttings report typed in - generally it will be associated with an LAS version 3.0 file)

The panel to the far right allows the user to turn the well name or api-number on or off which will be plotted next to the well symbols (default is no well labels next to the well symbols). The Java application Well Map version is the same with 2 PC batch files to run the respective areas,

- Run\_FCB.bat – Forest City Basin Data
- Run\_PlPr.bat – Pleasant Prairie Field Data

The last section in the ICKan Summary Web Page shows URL links to display the wells in a table form that meet the search criteria displayed above, the URL links will allow the user to display the following,

- All - shows all the wells that fit the above search criteria for the specific field.
- ELOG - Shows wells with well log image files
- LAS - Shows wells with Log ASCII Standard (LAS) version 2.0 files
- DST - Shows wells with Drill Stem Test (DST) files
- CORE - Shows wells with Measured Core Data files

The user can click on any of the URL links to display the well list summary page. The well list summary page is generated by an ORACLE PL/SQL stored procedure that build the web page from the stored procedure and displays it as a web page, e.g. for the Forest City Basin select “for Wells with Log ASCII Standard (LAS) 2.0 Files” which will show the following,



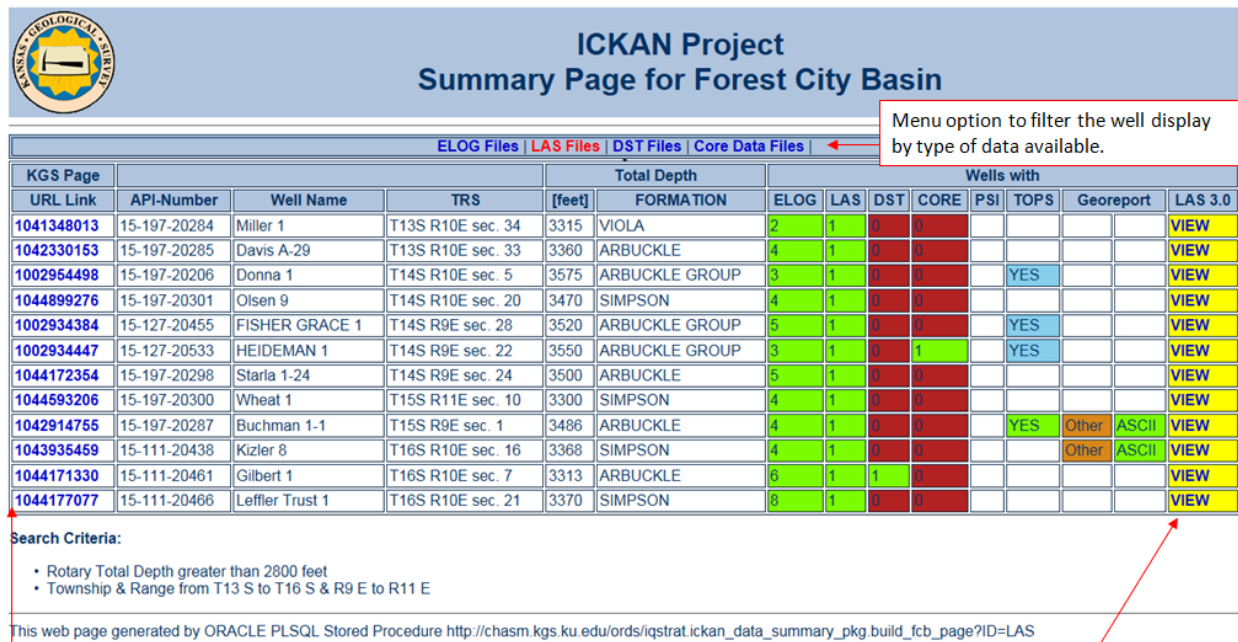

**KGS Page URL Link Column – Well Web Page:**

- Lists Well Header Information
- Documents from the KCC
- Elogs & URL Links
- Log ASCII Standard (LAS ) version 2.0 File URL Links
- Tops
- DST (Drill Stem Test) URL Links

**LAS 3.0 Column – Summary Page:**

- URL Link to Profile Plot Image as well as
- Log ASCII Standard (LAS) version 3.0 File URL Link
- Cuttings Report ASCII File URL Link
- CO<sub>2</sub> Project Well Tops List (selected by Paul Gerlach)

**Figure 23.** Summary page for Forest City Basin data.

The user initially selects the data type from the summary web page, but at the top of the page is a menu that allows the user to filter the well data for the area directly. The far left “KGS Page URL Link” column when selected will display the Kansas Geological Survey (KGS) well data page for the selected well. This page holds all the data that is in the KGS database and file server. The “LAS 3.0” column will display the profile image of the well and other data that is not listed on the KGS well data page.

The URL to display the summary well list for Log ASCII Standard (LAS) version 2.0 web pages for each area is,

Forest City Basin:

[http://chasm.kgs.ku.edu/ords/iqstrat.ickan\\_data\\_summary\\_pkg.build\\_fcb\\_page?ID=LAS](http://chasm.kgs.ku.edu/ords/iqstrat.ickan_data_summary_pkg.build_fcb_page?ID=LAS)

Pleasant Prairie:

[http://chasm.kgs.ku.edu/ords/iqstrat.ickan\\_data\\_summary\\_pkg.build\\_plpr\\_page?ID=LAS](http://chasm.kgs.ku.edu/ords/iqstrat.ickan_data_summary_pkg.build_plpr_page?ID=LAS)

The ICKan Summary web page allows the user to view all the wells that are within the search criteria for each study area. To access all the well information and type of data each well has are generated by ORACLE PL/SQL stored procedures which queries the KGS database using the search criteria identified

above for each study area and sends the data as either XML (Extensible Markup Language) data stream to the Java Web Apps or creating CSV (Comma Separated Values) web pages that the user can copy to a ASCII file.

## Well Data

The well summary web page identified wells with specific data types, i.e. Log ASCII Standard (LAS) version 2.0 files, Well tops, Drill Stem Test (DST) Files and Measured Core Data. These well data can be collected into one file, a Log ASCII Standard (LAS) version 3.0 file. The GEMINI Tools web apps (<http://www.kgs.ku.edu/Gemini/Tools/Tools.html>) saves the well data as LAS version 3.0 file, the file format developed by the <sup>(1)</sup>Canadian Well Logging Society. This version provides a means to collect all the well geological data in one file. Although the LAS 3.0 Format has default data types, the user can add their own data types to the file provided they use the primary section types, i.e., Parameter, Definition and Data whenever possible, which are briefly paraphrased below,

- **NewSection\_Parameter** contains a one dimensional data item consisting of (usually but not restricted to) one or two elements. Each line also contains a full description of that data.
- **NewSection\_Definition** although structurally identical to a Parameter Data lines (see above), each Column Definition line is used to describe each matching (by order) channel contained in the matching Column Data section. The name, unit, log code, description and format (if used) contained in each Column Definition line fully describe the channel it refers to.
- **NewSection\_Data | NewSection\_Definition** Each line contains a series of delimited data values. The delimiting character is defined by the value of the DLM parameter in the ~Version section. Descriptions of each data are contained in the matching Column Definition section.

## DST (Drill Stem Test) Data

The Drill Stem Test (DST) data on the KGS web site are PDF documents or TIFF images. <sup>(2)</sup>The DST pressure data can provide the Permeability of the tested formation from Horner equation:

$$P_o = P_f - m * \log_{10}[(T+\Delta T)/\Delta T]$$

where  $P_f$  is the extrapolation of  $\log_{10}[(T+\Delta T)/\Delta T]$  to zero for formation pressure and  $m$  is the slope of the line, where:

$$m = 162.6 * q * \mu * B / (K * h) \text{ [psi] / [log cycle]}$$

$q$  = flow rate [STB] / [day]  
 $\mu$  = viscosity [cp]  
 $B$  = Formation Volume Factor [RB] / [STB]  
 $h$  = vertical thickness of continuous porosity [ft]  
 $K$  = average effective permeability [md]

This states that the slope of the buildup is representative of a given fluid having physical properties  $\mu$ ,  $B$  flowing at a rate  $q$  through a formation having physical properties  $K * h$ .

Note: the flow rate ( $q$ ) is computed by using the total fluid volume in the recovery table and the total flow time computed from the pressure summary table and converting to days, i.e.  $q = (\text{Total Fluid Volume [bbls]} / \text{Total Flow Time [min]}) * (60 \text{ [min]} / \text{[hr]}) * (24 \text{ [hr]} / \text{[day]})$ .

The DST Pressure/Temperature Plot is first scanned into the user's PC. The GEMINI Tools Drill Stem Test (DST) Data Entry & Quantitative Analysis web site (<http://www.kgs.ku.edu/software/DST/>) was



created to digitize the DST Pressure and Temperature data. The program also allows the user to create a Horner Plot and compute the slope. The Pressure and Temperature data is saved in the Log ASCII Standard (LAS) version 3.0 file under the "Test" data section. The DST program saves the LAS file in a comma delimited format set in the "~Version" section of the LAS 3.0 file. This DST data section can be copied into a Comma Separated Values (CSV) file and used with any software available that analyzes DST.

In the Forest City Basin there are 7 wells with "DST" data, but only 4 were able to be digitized. As an example Eldridge 4-32 (15-197-20286) DST-5 pressure/temperature plot is digitized, see image below,

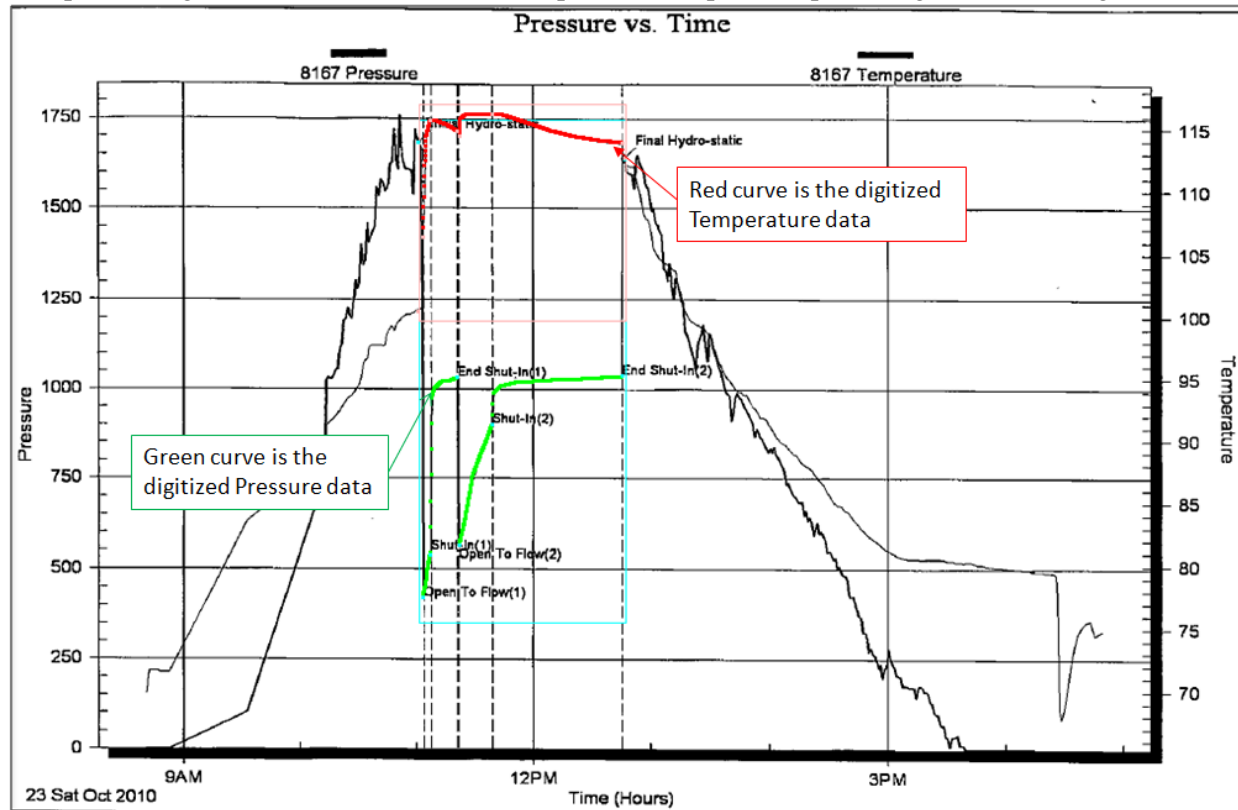

**Figure 24.** Pressure vs. Time plot for select Forest City Basin wells.

The data is saved as 0.1 minute intervals and transferred to the DST control panel. The user can then display a Horner Plot of the Shut-In Pressure data to determine the slope to infinite time.

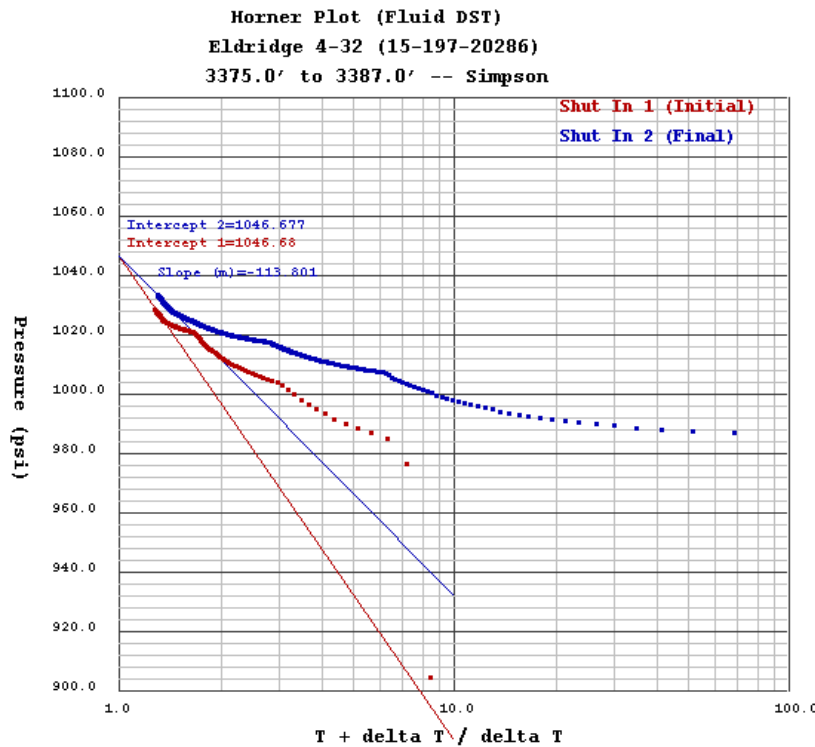

**Figure 25.** Example Horner plot for selected Eldridge well.

The summary data and the infinite pressure & temperature data are summarized in a table for each DST Test.

**Eldridge 4-32 (15-197-20286)**  
**Bottom Hole Temperature: 108 [deg F]**  
**Interval: 3375.0' to 3387.0'**  
**Formation: Simpson**

Time [mins]	Pressure [psig]	Temp [deg F]	Annotation
0	1683.87	100.60	Initial Hydrostatic
3	416.56	106.45	Open to Flow (1)
6.79	536.44	115.62	Shut In (1)
20	1028.81	114.72	End Shut In (1)
21	562.47	114.40	Open to Flow (2)
38	897.31	116.07	Shut In (2)
104	1033.64	113.84	End Shut In (2)
105	1637.95	112.66	Final Hydrostatic

Horner Plot:					
SHUT-IN 1			SHUT-IN 2		
Pressure [psig]	Exclude Below	Exclude Above	Pressure [psig]	Exclude Below	Exclude Above
1046.68	124	132	1046.677	408	660

Horner Plot:					
Open to Flow 1			Open to Flow 2		
Temp [deg F]	Exclude Below	Exclude Above	Temp [deg F]	Exclude Below	Exclude Above
			115.971	98	170

**Table 13.** Example summary table using DST, pressure, and temperature data.

### Geologist Cuttings Report

Geologist Cuttings Reports are also typed in to give the team members a visual of the lithology rock column. The data is saved in an ASCII text file in the following format,

*Bed Depth Start; Bed Depth End; Bed description*

A subsection of the Eldridge 4-32 (15-197-20286) ASCII File Cuttings Report:

3352; Simpson Shale  
3352; 3357; Sh, grayish green  
3357; 3360; LS, tan, slightly dolomitic, micro xln, lithic, dense, poor porosity, trace brown patchy stain, very slight odor NSFO  
3360; 3370; LS, tan-brown, micro xln, lithic, scat tan brown chert, no visible porosity, no show  
3370; Simpson Dolomite  
3370; 3375; Dolomitic limestone, white, light gray, mostly micro xln, w/ sec calc xln, tite, no show  
3375; 3379; SS, white, very fine grain, medium, well sorted, dense, w/ sec slight cement, trace spotted stain, no show  
3379; 3384; LS, tan, slightly dolomitic, micro xln, lithic, dense, poor porosity, 2% w/ coarse calc xln, trace brown patchy stain, very light odor NSFO  
3384; Simpson Sand  
3384; 3390; SS, tan, fine-medium grain, subround, fair sorted, mostly heavy calc cement, trace heavy tary black oil & gil stain, good odor  
3390; 3395; SS, clear frosted free quartz, fine coarse, sub round-round medium  
3395; 3400; SS, white cluster of medium grain and very fine grain, medium, well sort, dense no show  
3400; 3410; SS, white, cluster of medium grain and very fine grain, medium, well sorted, dense no show  
3410; 3420; SS, white, very fine grain, medium, well sorted, dense no show  
3420; 3430; SS, white, very fine green, sub round, well sorted, sec silic cement, dense, trace green chlorite, no show  
3430; 3432; SS, white, very fine green, sub round, well sorted, sec silic cement, dense, grass green chlorite, no show  
3432; 3435; SS, white, mostly very fine grain, subround, well sorted, sec silic cement, dense 5% fine-medium, 2% w/ black tary-gil patchy sat stn, trace dism pyrite in few cutn, NSO  
3435; 3444; SH, aqua green claystone, w/ fine-medium, angular-medium quartz grain, dism green chlorite, Shale black w/ dism pyrite & pyrite cluster  
3444; 3446; Chert, light gray - light grayish tan translucent  
3446; 3447; Dol, light brown tan, micro xln w/ chert intraclast  
3447; 3449; Dol, light brown tan, very fine xln, dense, trans light brown fine xln, scattered light gray translucent chert

The bed description is the lithology, color, texture, porosity, other minerals, etc. in whatever order the geologist deems important. The GEMINI Tools - LAS File Viewer (<http://www.kgs.ku.edu/stratigraphic/LAS/>) web site allows the user to import, Log ASCII Standard (LAS) version 2.0 & 3.0 files, well tops, measured core data and the geologist cuttings report or core descriptions and plots the data in a profile plot by depth. As an example the well profile data page for the Eldridge 4-32 (15-197-20286) can be found at [http://chasm.kgs.ku.edu/ords/igstrat.ickan\\_data\\_summary\\_pkg.build\\_image\\_page?sKID=1042914076](http://chasm.kgs.ku.edu/ords/igstrat.ickan_data_summary_pkg.build_image_page?sKID=1042914076) with links to the LAS version 3.0 file, geologist cuttings ASCII File and the profile image of the cuttings report plotted. The geologist cuttings report is parsed and plotted by section with the individual sections having a unique plot track, i.e. Rock Color, Lithology Rock Column, etc, e.g. for the Eldridge 4-32 (15-

197-20286) cuttings report plot,

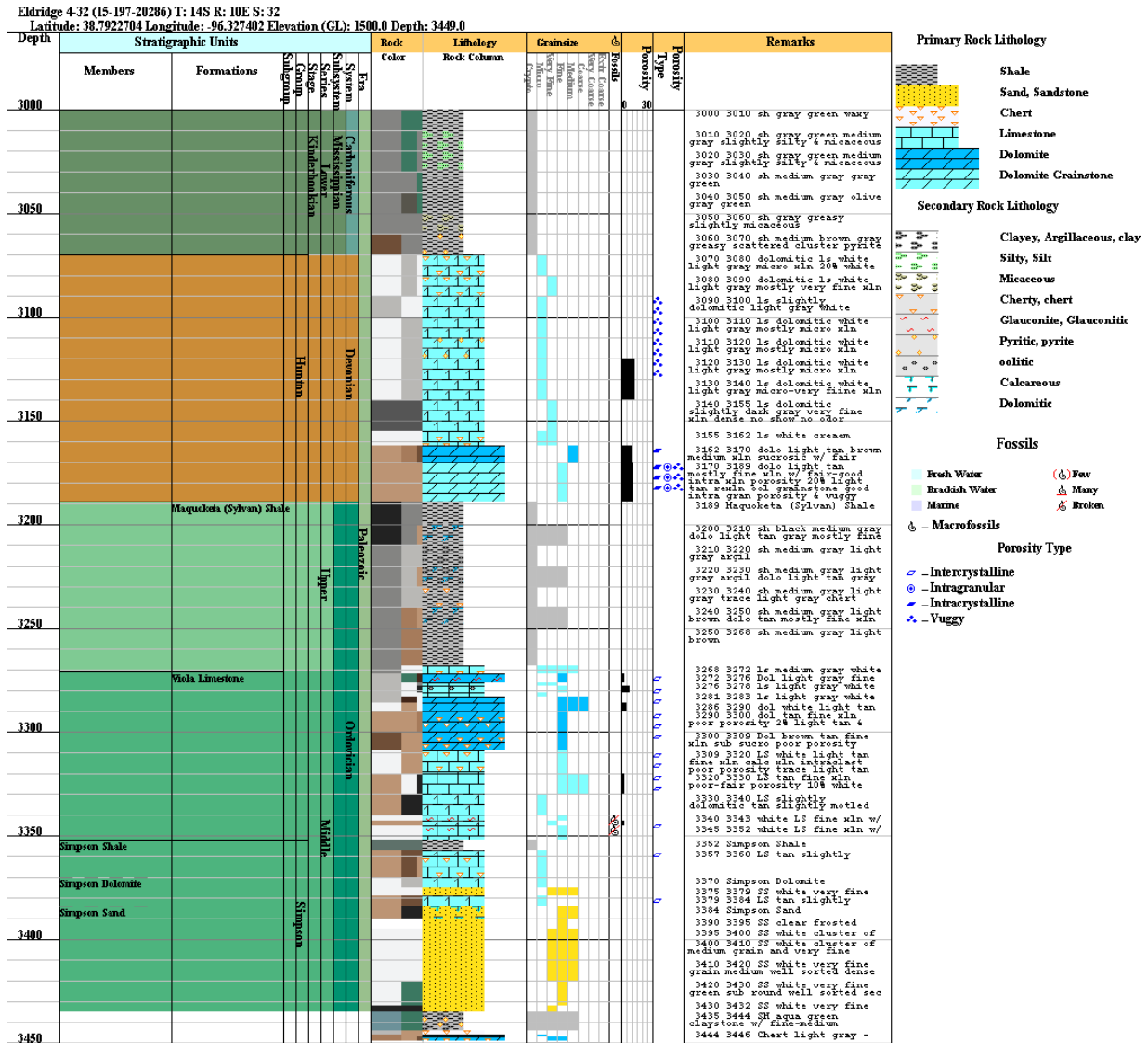

Figure 26. Well column generated using Geologist's well cuttings report.

### Log ASCII Standard (LAS) version 3.0 File

For all wells in the study area that meet the search criteria the well data is collected using the GEMINI Tools - LAS File Viewer (<http://www.kgs.ku.edu/stratigraphic/LAS/>) web site which allows the user to import, Log ASCII Standard (LAS) version 2.0 & 3.0 files, well tops, measured core data and the geologist cuttings report or core descriptions and plots the data in a profile plot by depth. Specifically for the wells that have LAS version 2.0 files, the available data from the KGS web site is downloaded into the LAS File Viewer Applet and plotted. The data is then saved to a Log ASCII Standard (LAS) version 3.0 file and can be accessed from the "LAS 3.0" column URL link for the wells on the LAS Files Summary Page, e.g. [http://chasm.kgs.ku.edu/ords/igqstrat.ickan\\_data\\_summary\\_pkg.build\\_fcb\\_page?ID=LAS](http://chasm.kgs.ku.edu/ords/igqstrat.ickan_data_summary_pkg.build_fcb_page?ID=LAS)

### Cross Section Plot

Another tool that is useful is the GEMINI Tools - Cross Section Tool

([http://www.kgs.ku.edu/stratigraphic/CROSS\\_SECTION/](http://www.kgs.ku.edu/stratigraphic/CROSS_SECTION/)) which allows the user to plot up to 4 wells together to view the sub surface over a finite region of space, e.g.

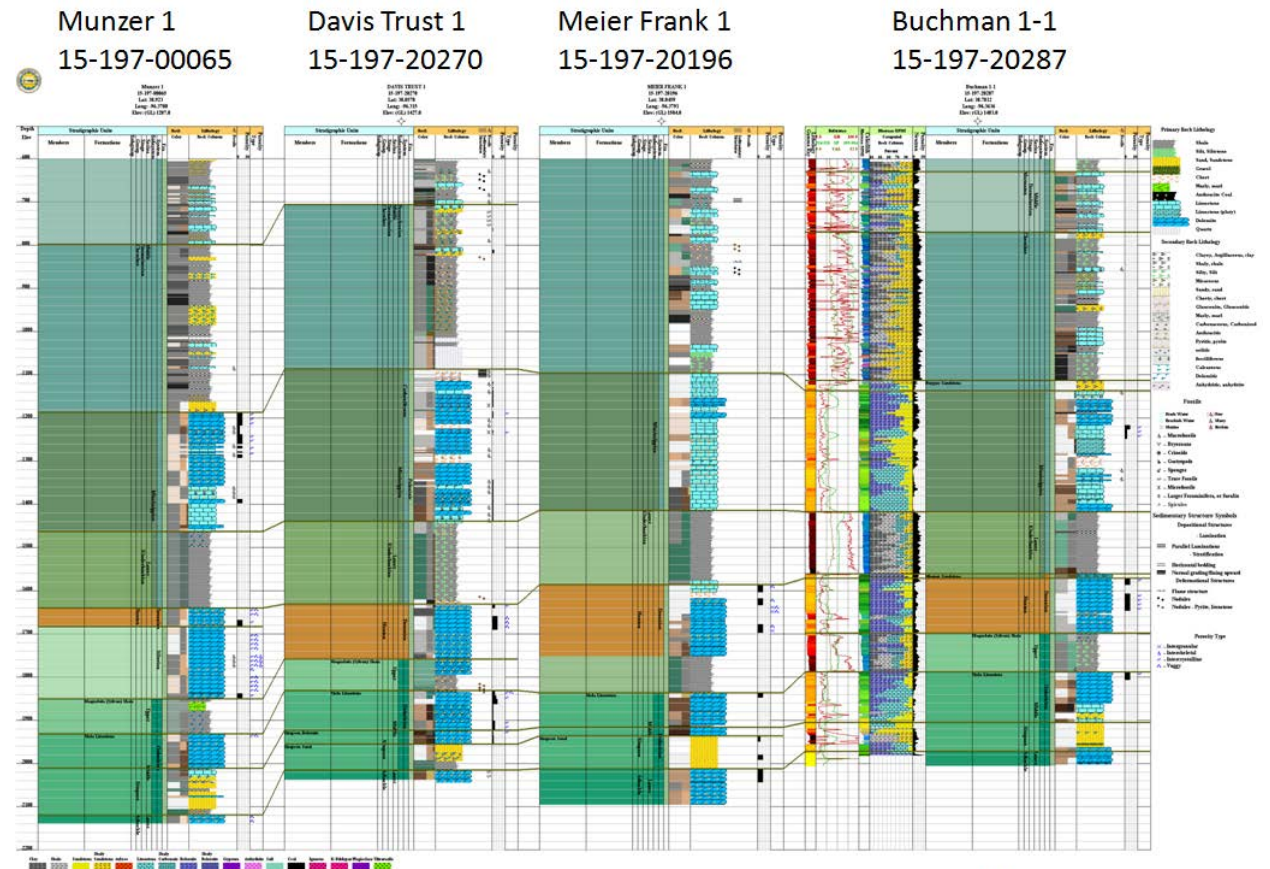

**Figure 27.** Cross section plot using the GEMINI Tools cross section tool.

The cross section is constructed of 4 wells with LAS version 3.0 files with primarily geologist cuttings reports, with the Buchman 1-1 having a full log data suite with the cuttings report. The wells are datum by elevation.

**References:**

- (1) LAS (Log ASCII Standard) Canadian Well Logging Society: <http://www.cwls.org/las/>
- (2) Help: Quantitative Analysis Equations – Fluid DST web page - Transmissibility ( $K \cdot h / \mu$ ), Permeability Thickness ( $K \cdot h$ ), Permeability ( $K$ ) section [http://www.kgs.ku.edu/software/DST/HELP/horner/qa\\_fluid.html](http://www.kgs.ku.edu/software/DST/HELP/horner/qa_fluid.html)

**Subtask 7.2 - Public presentations**

Nothing to report.

**Subtask 7.3 - Publications**

Nothing to report.

## Organizational Chart

<b>Organizational Chart</b> <b>"Integrated CCS for Kansas (ICKan)"</b>
<b>Project Management &amp; Coordination, Geological Characterization</b>
<b>Kansas Geological Survey</b> <b>University of Kansas</b> <b>Lawrence, KS</b> Tandis Bidgoli, Joint-PI - structural geology, fault reactivation/leakage risks W. Lynn Watney, Co-PI - project leader, carbonate sedimentology/stratigraphy Yvehen 'Eugene' Holubnyak, Co-PI - lead engineer, dynamic modeling K. David Newell - Co-PI, site characterization John Doveton, Co-PI - log petrophysics Susan Stover, Key Personnel - public outreach, stakeholder alignment, policy analysis Mina FazelAlavi, Key Personnel - petrophysical and well test analyses John Victorine, Key Personnel - data management; website; web-based tools Jennifer Hollenbach - project coordinator
<b>Improved Hydrocarbon Recovery, LLC</b> <b>Lawrence, KS</b> Martin Dubois, Joint-PI, project manager, reservoir modeling, economic feasibility
<b>CO2 Source Assessments, Capture &amp; Transportation, Economic Feasibility</b>
<b>Linde Group (Americas Division)</b> <b>Houston, TX</b> Krish Krishnamurthy, Head of Group R&D - CO2 sources, capture tech., and economics Kevin Watts, Dir. O&G Business Development - CO2 sources, transport., and economics
<b>Policy Analysis, Public Outreach &amp; Acceptance</b>
<b>Great Plains Institute</b> <b>Minneapolis, MN</b> Brendan Jordan, Vice President - policy & strategic initiatives, stakeholder facilitation Brad Crabtree, V.P. Fossil Energy - policy and project development, strategic initiatives Jennifer Christensen, Senior Associate - statutory and regulatory policy analysis Dane McFarlane, Senior Research Analyst - analytics for policy research & development



**Energy, Environmental, Regulatory, & Business Law & Contracts**

**Depew Gillen Rathbun & McInteer, LC**

**Wichita, KS**

Christopher Steincamp, Attorney at Law - legal, regulatory, & policy analysis

Joseph Schremmer - Attorney at Law - legal, regulatory, & policy analysis

**Committed Project Partners**

**CO2 Sources**

**Westar Energy**

Brad Loveless, Executive Director of Environmental Services

**Kansas City Board of Public Utilities**

Ingrid Seltzer, Director of Environmental Services

**Sunflower Electric Power Corporation**

Clare Gustin, Vice President of Member Services & External Affairs

**CHS, Inc. (McPherson Refinery)**

Rick Johnson, Process Engineering and Development Manager

Richard K. Leicht, Vice President of Refining

**Kansas Oil & Gas Operators**

**Blake Production Company, Inc. (Davis Ranch and John Creek fields)**

Austin Vernon, Vice President

**Knighton Oil Company, Inc. (John Creek field)**

Earl M. Knighton, Jr., President

**Casillas Petroleum Corp (Pleasant Prairie field)**

Chris K. Carson, Vice President of Geology & Exploration

**Berexco, LLC (Wellington, Cutter, and other O&G fields)**

Dana Wreath, Vice President

**Stroke of Luck Energy & Exploration, LLC (Leach & Newberry fields)**

Ken Walker, Operator

**Regulatory**

**Kansas Department of Health & Environment**

Division of Environment

John W. Mitchell, Director

### Gantt Chart and Accomplishments

Task	Task Name	Deadline	2017												2018							
			3	4	5	6	7	8	9	10	11	12	1	2	3	4	5	6	7	8		
<b>Task 1.0</b>	<b>Project Management and Planning Integrated CCS for Kansas (ICKan)</b>																					
Subtask 1.1	Fulfill requirements for National Environmental Policy Act (NEPA)	complete	█																			
Subtask 1.2	Conduct a kick-off meeting to set expectations	complete	█																			
Subtask 1.3	Conduct regularly scheduled meetings and update tracking	ongoing				█			█			█				█			█			
Subtask 1.4	Monitor and control project scope	ongoing	█	█	█	█	█	█	█	█	█	█	█	█	█	█	█	█	█			
Subtask 1.5	Monitor and control project schedule	ongoing	█	█	█	█	█	█	█	█	█	█	█	█	█	█	█	█	█			
Subtask 1.6	Monitor and control project risk	ongoing	█	█	█	█	█	█	█	█	█	█	█	█	█	█	█	█	█			
Subtask 1.7	Maintain and revise the Data Management Plan including submittal of data to NETL-EDX	ongoing	█	█	█	█	█	█	█	█	█	█	█	█	█	█	█	█	█			
Subtask 1.8	Revisions to the Project Management Plan after submission	ongoing	█	█	█	█	█	█	█	█	█	█	█	█	█	█	█	█	█			
Subtask 1.9	Submit reports as prescribed	ongoing				█			█			█			█			█				
Subtask 1.10	Develop an integrated strategy for commercial scale CCS	Jan 2018							█	█	█	█	█	█	█	█	█	█	█			
<b>Task 2.0</b>	<b>Establish a Carbon Capture and Storage (CCS) Coordination Team</b>																					
Subtask 2.1	Identify additional CCS team members	Aug 2017		█	█	█	█	█	█	█	█	█	█	█								
Subtask 2.2	Identify additional stakeholders that should be added to the CCS team	Aug 2017		█	█	█	█	█	█	█	█	█	█	█								
Subtask 2.3	Recruit and gain commitment of additional CCS team members identified	Sept 2017		█	█	█	█	█	█	█	█	█	█	█								
Subtask 2.4	Conduct a formal meeting that includes Phase I team and committed Phase II team members	Oct 2017											█									
<b>Task 3.0</b>	<b>Develop a plan to address challenges of a commercial-scale CCS Project</b>																					
Subtask 3.1	Identify challenges and develop a plan to address challenges for CO2 capture	Jan 2018																				
Subtask 3.2	Identify challenges and develop a plan to address challenges for CO2 transportation and injectio	Jan 2018																				
Subtask 3.3	Identify challenges and develop a plan to address challenges for CO2 storage in geologic compl	Jan 2018																				
<b>Task 4.0</b>	<b>Perform a high level technical sub-basinal evaluation using NRAP and related DOE tools</b>																					
Subtask 4.1	Review storage capacity of geologic complexes identified in this proposal and consider alternati	complete																				
Subtask 4.2	High-level technical analysis using NRAP-IAM-CS and other tools	Jan 2018																				
Subtask 4.3	Compare results using NRAP with previous methods	Jan 2018																				
Subtask 4.4	Develop an implementation plan and strategy for commercial-scale, safe and effective CO2 stor	Jan 2018																				
<b>Task 5.0</b>	<b>Perform a high level technical CO2 source assessment for capture</b>																					
Subtask 5.1	Review current technologies using NATCARB, Global CO2 Storage Portal, and KDM	Dec 2017																				
Subtask 5.2	Determine novel technologies or approaches for CO2 capture	Dec 2017																				
Subtask 5.3	Develop an implementation plan and strategy for cost effective and reliable carbon capture	Jan 2018																				
<b>Task 6.0</b>	<b>Perform a high level technical assessment for CO2 transportation</b>																					
Subtask 6.1	Review current technologies or CO2 transportation	Dec 2017																				
Subtask 6.2	Determine novel technologies or approaches for CO2 capture	Dec 2017																				
Subtask 6.3	Develop a plan for cost-efficient and secure transportation infrastructure	Jan 2018																				
<b>Task 7.0</b>	<b>Technology Transfer</b>																					
Subtask 7.1	Maintain website on KGS server to facilitate effective and efficient interaction of the team	ongoing	█	█	█	█	█	█	█	█	█	█	█	█	█	█	█	█	█			
Subtask 7.2	Public presentations	ongoing				█			█			█			█			█				
Subtask 7.3	Publications	ongoing				█			█			█			█			█				



## Budgetary Information

### Cost Plan Status

COST PLAN/STATUS DE-FE0029474 (KUCR FED0076651)						
BP1 Starts: 3/15/17 through 9/15/18 - one budget period						
Baseline Reporting Quarter	3/15/17 - 6/15/17 Q1	6/16/17 - 9/15/17 Q2	9/16/17 - 12/15/17 Q3	12/16/17 - 3/15/18 Q4	3/16/18 - 6/15/18 Q5	6/16/18 - 9/15/18 Q6
<b>Baseline Cost Plan (from SF-424A)</b>	(from 424A, Sec. D)					
Federal Share	\$197,247.00	\$197,247.00	\$197,247.00	\$197,247.00	\$197,254.00	\$197,255.00
Non-Federal Share	\$49,598.00	\$49,598.00	\$49,598.00	\$49,601.00	\$49,599.00	\$49,599.00
Total Planned (Federal and Non-Federal)	\$246,845.00	\$246,845.00	\$246,845.00	\$246,848.00	\$246,853.00	\$246,854.00
Cumulative Baseline Cost	\$246,845.00	\$493,690.00	\$740,535.00	\$987,383.00	\$1,234,236.00	\$1,481,090.00
<b>Actual Incurred Costs</b>						
Federal Share	\$98,249.07	\$0.00	\$0.00	\$0.00	\$0.00	\$0.00
Non-Federal Share	\$4,923.39	\$0.00	\$0.00	\$0.00	\$0.00	\$0.00
Total Incurred Costs-Quarterly (Federal and Non-Federal)	\$103,172.46	\$0.00	\$0.00	\$0.00	\$0.00	\$0.00
Cumulative Incurred Costs	\$103,172.46	\$103,172.46	\$103,172.46	\$103,172.46	\$103,172.46	\$103,172.46
<b>Variance</b>						
Federal Share	\$98,997.93	\$197,247.00	\$197,247.00	\$197,247.00	\$197,254.00	\$197,255.00
Non-Federal Share	\$44,674.61	\$49,598.00	\$49,598.00	\$49,601.00	\$49,599.00	\$49,599.00
Total Variance-Quarterly (Federal and Non-Federal)	\$143,672.54	\$246,845.00	\$246,845.00	\$246,848.00	\$246,853.00	\$246,854.00
Cumulative Variance	\$143,672.54	\$390,517.54	\$637,362.54	\$884,210.54	\$1,131,063.54	\$1,377,917.54

## Appendices

### Appendix A

#### Appendix A: Draft statutes to address statutory challenges related to CCS in Kansas

Joseph A. Schremmer and Charles C. Steincamp (Depew Gillen Rathbun & McInteer)

#### Draft Statute Amendments

#### K.S.A.

#### \_\_\_\_\_. Ownership of pore space.

- (a) The ownership of all pore space in all strata below the surface lands and waters of this state is declared to be vested in the several owners of the surface estate.
- (b) A conveyance of the surface estate in real property shall pass all the estate of the grantor's interest in the pore space in all strata below the surface of such real property unless the intent to pass a less estate shall expressly appear or be necessarily implied in the terms of the grant.

#### K.S.A. § 17-618

#### 17-618. Eminent domain, exercise by sundry corporations and partnerships.

Lands may be appropriated for the use of macadam-road, plank-road, hospital corporation or association, telegraph and telephone corporations, electric, hydraulic, irrigating, milling and manufacturing corporations using power, oil companies, geologic carbon storage utilities, pipeline companies, and for the piping of gas in the same manner as is provided in K.S.A. 26-501 to 26-516, inclusive, and any macadam-road, plank-road, telegraph and telephone corporations, hydraulic, irrigating, oil company, geologic carbon storage utility, pipeline company, gas company, partnership holding a certificate of convenience as a public utility issued by the state corporation commission, milling or manufacturing corporation using power desiring the right to dam or take water from any stream, to conduct water in canals or raceways or pipes, or to conduct compressed air in pipes, or to conduct oil in pipes or conduct gas in pipes, or transmit power or communications by shafting, belting, or belting and pulleys, or ropes and pulleys, or by electrical current, or by compressed air, may obtain such right or the right-of-way for all necessary canals, raceways, pipes, shafting, belting and pulleys, ropes and pulleys or wires or cables in manner as aforesaid; and such canals, raceways, pipes, shafting, belting, belting and pulleys, ropes and pulleys or wires or cables may be laid, carried or stretched on, through or over any land or lot, or along or upon any stream of water, using so much of the water thereof as may be needed for any of the purposes aforesaid, or through any street or alley or public ground of any city of the second or third class: Provided, That no such canal or raceway shall be located through any street or alley or any public ground of any city without

the consent of the municipal authorities thereof: Provided further, That it shall be unlawful for any person or corporation to locate or construct any irrigating canal or raceway along or upon any stream of water or take and use the water of any stream in such manner as to interfere with or in any wise hinder, delay or injure any milling or irrigating improvements already constructed or located along or upon any stream of water, or to diminish the supply of water flowing to or through any established irrigating canal: Provided further, That in case of the erection of a dam, the report of the commissioners, instead of defining the quantity and boundaries of the land overflowed, shall designate particularly the height of such dam.

## **K.S.A. § 55-**

### **55-\_\_\_\_. Definitions**

As used in this act

- (a) “underground storage” shall mean storage in a subsurface stratum or formation of the earth;
- (b) “carbon dioxide” shall mean carbon dioxide gas produced from anthropogenic sources;
- (c) “native gas” shall mean gas which has not been previously withdrawn from the earth;
- (d) “geologic carbon storage utility” shall mean any person, firm or corporation authorized to do business in this state and engaged in the business of storing carbon dioxide by means of injection into underground storage, within or through this State for beneficial use or ultimate storage and disposal;
- (e) “commission” shall mean the state corporation commission.
- (f) “pore space” shall mean openings between or within geologic material under surface lands whether natural or artificially created, which may be referred to as voids or interstices.
- (g) “underground carbon dioxide storage facility” shall mean a facility storing carbon dioxide in subsurface pore space.

## **K.S.A. § 55-**

### **55-\_\_\_\_. Public interest and welfare.**

The underground storage of carbon dioxide promotes protecting the health, safety and property of the people of the State, and preventing escape of carbon dioxide into the atmosphere and pollution of soil, and surface and subsurface water detrimental to the public

health or to plant, animal and aquatic life and promotes the public interest and welfare of this state.

Therefore in the manner hereinafter provided the commission may find and determine that the underground storage of carbon dioxide as hereinbefore defined is in the public interest.

### **K.S.A. § 55-**

#### **55-\_\_\_\_\_. Appropriation of certain property.**

Any geologic carbon storage utility may appropriate for its use for the underground storage of carbon dioxide fee simple absolute in all surface and mineral interests in any subsurface stratum or formation in any land which the commission shall have found to be suitable and in the public interest for the underground storage of carbon dioxide, and in connection therewith may appropriate such other interests in property as may be required adequately to examine, prepare, maintain and operate such underground carbon dioxide storage facility. The right of appropriation hereby granted shall be without prejudice to the rights of the owner of said lands or of other rights or interests therein to drill or bore through the underground stratum or formation so appropriated in such manner as shall comply with orders, rules and regulations of the commission issued for the purpose of protecting underground storage strata or formations against pollution and against the escape of carbon dioxide therefrom and shall be without prejudice to the rights of the owner of said lands or other rights or interests therein as to all other uses thereof.

### **K.S.A. § 55-**

#### **55-\_\_\_\_\_. Underground storage of carbon dioxide; certificate of commission; notice and hearing; assessment of costs; disposition of moneys.**

(a) Any geologic carbon storage utility desiring to exercise the right of eminent domain as to any property for use for underground storage of carbon dioxide shall, as a condition precedent to the filing of its petition in the district court, obtain from the commission a certificate setting out findings of the commission:

(1) That the underground stratum or formation sought to be acquired is suitable for the underground storage of carbon dioxide and that its use for such purposes is in the public interest; and

(2) the amount of recoverable oil and native gas, if any, remaining therein.

(b) As a condition to issuing any such certificate, the commission shall require that:

(1) the applicant post a bond in an amount the commission determines is sufficient to assure the costs of plugging all injection wells and completing all

reclamation work required by the commission, and complying with all permits, rules, and regulations of the commission applicable to the proposed underground storage project for the life of the project; and

(2) purchase and maintain a policy or policies of liability insurance covering any damage injected carbon dioxide may cause, including damage caused by carbon dioxide that escapes from the underground storage facility. Such policy or policies shall provide limits of not less than \$\_\_\_\_\_. Such policy or policies shall be maintained continually until such time as the commission shall issue a certificate of project completion covering the underground storage facility pursuant to K.S.A. 55-1211, and amendments thereto.

(c) The commission shall issue no such certificate until after public hearing is had on application and upon reasonable notice to interested parties in accordance with the provisions of the Kansas administrative procedure act. Subject to the provisions of K.S.A. 55-1636 et seq., and amendments thereto, the applicant shall be assessed an amount equal to all or any part of the costs of such proceedings and the applicant shall pay the amount so assessed.

(d) All provisions of K.S.A. 66-106, 66-118a, 66-118b, 66-118c, 66-118d, 66-118e, 66-118j and 66-118k, and amendments thereto, shall be applicable to all proceedings of the commission under this act, inclusive, and amendments thereto.

(e) The state corporation commission shall remit all moneys received by or for it for costs assessed under this section to the state treasurer in accordance with the provisions of K.S.A. 75-4215, and amendments thereto. Upon receipt of each such remittance, the state treasurer shall deposit the entire amount in the state treasury to the credit of the carbon dioxide injection well and underground storage fund created by K.S.A. 55-1638, and amendments thereto.

(f) A certificate issued under this section may be assigned by the owner thereof to a third party who as determined by the commission complies with all the terms and conditions of such certificate and such transfer is approved following notice and hearing before the commission.

## K.S.A. § 55-

### 55-\_\_\_\_\_. Eminent domain procedure.

Any geologic carbon storage public utility, having first obtained a certificate from the commission as hereinbefore provided, desiring to exercise the right of eminent domain for the purpose of acquiring property for the underground storage of carbon dioxide shall do so in the manner provided in K.S.A. 26-501 to 26-516, inclusive. The petitioner shall file the certificate of the commission as a part of its petition and no order by the court granting said petition shall be entered without such certificate being filed therewith. The appraisers in awarding damages hereunder shall also take into consideration the amounts of recoverable oil and native gas remaining in the property sought to be appropriated and for such purposes shall receive as prima facie evidence of such amounts the findings of the

commission with reference thereto.

**K.S.A. § 55-**

**55-\_\_\_\_\_. Sale of state-owned lands for underground storage of carbon dioxide; conditions.**

The director of the state department of administration, with the approval of the state finance council, may sell to a person, firm or corporation lands owned by the state of Kansas for the underground storage of carbon dioxide by such person, firm or corporation. All such sales shall be on such terms and conditions as the director of the state department of administration, with the approval of the state finance council, shall prescribe. Every such sale shall describe the subsurface stratum or formation in such lands which is to be utilized for such storage. Any sale made pursuant to the provisions of this section shall be without prejudice to the rights of the state as the owner of such lands, or any lessee of the oil and gas rights thereof, to develop other subsurface strata or formations so leased in such manner as will comply with existing or hereafter promulgated rules and regulations of the state corporation commission issued for the purpose of protecting underground carbon dioxide storage stratum or formation.

All proceeds of such sales shall be remitted to the state treasurer in accordance with the provisions of K.S.A. 75-4215, and amendments thereto. Upon receipt of each such remittance, the state treasurer shall deposit the entire amount in the state treasury to the credit of the carbon dioxide injection well and underground storage fund created by K.S.A. 55-1638, and amendments thereto.

**K.S.A. § 55-**

**55-\_\_\_\_\_. Plat map of location of underground carbon dioxide storage facility required.**

The owner of an underground carbon dioxide storage facility shall provide to the state corporation commission a plat map identifying the location of such facility and a description of the geological formation or formations to be used for storage.

**K.S.A. § 55-**

**55-\_\_\_\_\_. Property rights to injected carbon dioxide gas established.**

(a) Title to carbon dioxide produced from a discrete source and reduced to possession shall remain with the generator until transferred to the owner of a carbon dioxide storage facility unless title to such carbon dioxide is expressly transferred by contract or other written instrument. Transporters of carbon dioxide shall be common carriers unless expressly agreed.

(b) In no event shall such carbon dioxide be subject to the right of the owner of the surface of such lands or of any mineral interest therein, under which such carbon dioxide

storage facility lies, or of any person, other than the owner of the carbon dioxide storage facility, to produce, take, reduce to possession, vent, release, allow escape, either by means of the law of capture or otherwise, waste, or otherwise interfere with or exercise any control over such carbon dioxide.

Nothing in this subsection shall be deemed to affect the right of the owner of the surface of such lands or of any mineral interest therein to drill or bore through the underground storage fields, sands, reservoirs and facilities in such a manner as will protect such fields, sand, reservoirs, environment and facilities against pollution and the escape of the carbon dioxide being stored.

(c) The owner of the carbon dioxide storage facility, such owner's heirs, successors and assigns shall have the right to compel compliance with this section by injunction or other appropriate relief by application to a court of competent jurisdiction.

(d) While the carbon dioxide storage facility owner holds title to injected carbon dioxide, the owner shall be liable for any damage the carbon dioxide may cause, including damage caused by carbon dioxide that escapes from the storage facility.

(e) Carbon dioxide produced from a discreet source and reduced to possession that is disposed of in ways other than in accordance with this act shall remain the property of the generator and the generator shall be liable for any damage the carbon dioxide may cause and to provide for lawful injection or management of the carbon dioxide. It shall not constitute a defense to the generator that the generator acted through an independent contractor in the transportation or disposal of the carbon dioxide.

(f) Nothing herein shall be construed to prevent the owner of a carbon dioxide storage facility from transferring title to the carbon dioxide or the carbon dioxide storage facility by contract to a third party.

## **K.S.A. § 55-**

### **55-\_\_\_\_\_. Certificate of project completion; release; transfer of title and custody.**

(a) Not less than ten (10) years after carbon dioxide injections into an underground carbon dioxide storage facility end and upon application by the owner of such facility, the commission may issue a certificate of project completion following public notice and hearing. The commission shall establish notice requirements for this hearing.

(b) The certificate may be issued only upon a showing by the applicant that:

(1) The applicant is in full compliance with all laws governing the underground carbon dioxide storage facility.

(2) The applicant has resolved all pending claims regarding the underground carbon dioxide storage facility.

(3) That the underground carbon dioxide storage facility is reasonably

expected to retain the carbon dioxide stored in it.

(4) That the carbon dioxide in the underground carbon dioxide storage facility has become stable. Stored carbon dioxide is stable if it is essentially stationary or, if it is migrating or may migrate, that any migration will be unlikely to cross the boundary of the subsurface stratum of formation in which the carbon dioxide is stored.

(5) That all wells, equipment, and facilities to be used in the postclosure period are in good condition and retain mechanical integrity.

(6) That the applicant has plugged wells, removed equipment and facilities, and completed all reclamation work as required by the commission.

(c) Once a certificate is issued under this section:

(1) All right, title, and interest in and to the underground carbon dioxide storage facility and to the stored carbon dioxide transfers, without payment of any compensation, to the state. Title acquired by the state includes all rights and interests in, and all responsibilities and liabilities associated with, the stored carbon dioxide and the underground carbon dioxide storage facility.

(2) The applicant and all persons who generated, transported, or injected any carbon dioxide into the underground carbon dioxide storage facility are released from all regulatory requirements associated with the underground carbon dioxide storage facility.

(3) Any bonds posted by the applicant must be released.

(4) Monitoring and managing the underground carbon dioxide storage facility is the state's responsibility to be overseen by the commission until such time as the federal government assumes responsibility for the long-term monitoring and management of such facility.

**K.S.A. § 66-104(h)**

(h) The term "public utility" shall also include an entity engaged in the transportation or storage of carbon dioxide as those terms are defined in K.S.A. 55-\_\_\_\_\_.



## Appendix B

### Technical analysis of the Forest City Basin geologic complex: Davis Ranch and John Creek Fields

Martin K. Dubois<sup>1</sup>, Yevhen Holubnyak<sup>2</sup>, Andrew Hollenbach<sup>3</sup>, Fatemeh FazelAlavi<sup>2</sup>, Dave Newell<sup>2</sup>

1 – Improved Hydrocarbon recovery, LLC, 2 – Kansas Geological Survey, 3 – University of Kansas

#### ABSTRACT

The two largest oil fields in relative close proximity to Kansas' largest coal-fired power plant, Jeffrey Energy Center, comprise the Forest City Basin Complex. A high-level technical analysis was conducted on the two fields, the Davis ranch and John Creek fields to determine the volume of CO<sub>2</sub> that could be stored and the rate at which CO<sub>2</sub> could be injected into two saline aquifers, Simpson sandstone (3250ft) and Arbuckle dolomite(3350ft), beneath the producing horizons. The analysis followed a standard work flow including 1) gathering and processing basic well and engineering data, 2) stratigraphic and structural 2D mapping, 3) petrophysical studies, 4) building a 3D cellular property model that was then upscaled for simulation, and 5) simulating injection and storage in a dynamic model. It was determined that the two fields that make up the Forest City Basin storage complex, the Davis Ranch and John Creek fields, in combination, are unlikely to be capable of storing 50 million tonnes (Mt) of CO<sub>2</sub>, the targeted storage volume. Although injection rates are adequate averaging 2700 tonnes/day, the dynamic simulation projects a total of 24.6 Mt stored over a 25-year period. Initial work on evaluating the vertical seals, comparing the geochemistry of the reservoir brines, suggests that the target CO<sub>2</sub> injection zones, the Simpson and Arbuckle, are isolated from each other as well as from overlying strata. Additional risk evaluations have been postponed because of the apparent shortfall in reservoir capacity.

#### INTRODUCTION

The Forest City Basin (FCB) geologic complex is one of two geologic complexes identified as potential sites for storing >50 million tonnes (Mt) CO<sub>2</sub> as part of the Integrated CCS for Kansas (ICKan), contract number DE-FE0029474 under the DOE/NETL CarbonSAFE program. The other geologic complex is the Hugoton complex. The Pleasant Prairie field (Hugoton complex), numbered 1 in Figure 1, is the subject of a separate study. The subject of this study (are the Davis Ranch and John Creek fields, located in Wabaunsee and Morris Counties in Northeast Kansas and numbered 11 and 12 in Figure 1.

The Davis Ranch and John Creek fields (FCB complex), numbered 11 and 12 in Figure 1, were chosen for this study largely due to their proximity to the Jeffrey Energy Center, the largest CO<sub>2</sub> source in Kansas located 40-50 miles to the northeast. The two fields are the largest oil fields in the Forest City Basin with the Davis Ranch having produced 9.1 million barrels (mmbo) of oil from the Kansas City and Hunton, but primarily from the Viola since discovered in 1949, and the John Creek having produced 10.3 mmbo from the Viola since its discovery in 1953. The Simpson Sandstone and the Arbuckle (dolomite) are saline aquifers lying beneath the producing intervals and are potential targets for CO<sub>2</sub> storage (Figure 2). Technical evaluations of the two saline aquifers beneath the oil producing horizons were performed using publicly available data supplemented with data provided by the two field operators, Davis Ranch - Blake Production Co., and John Creek - Blake Production Co. and Knighton Oil Co.

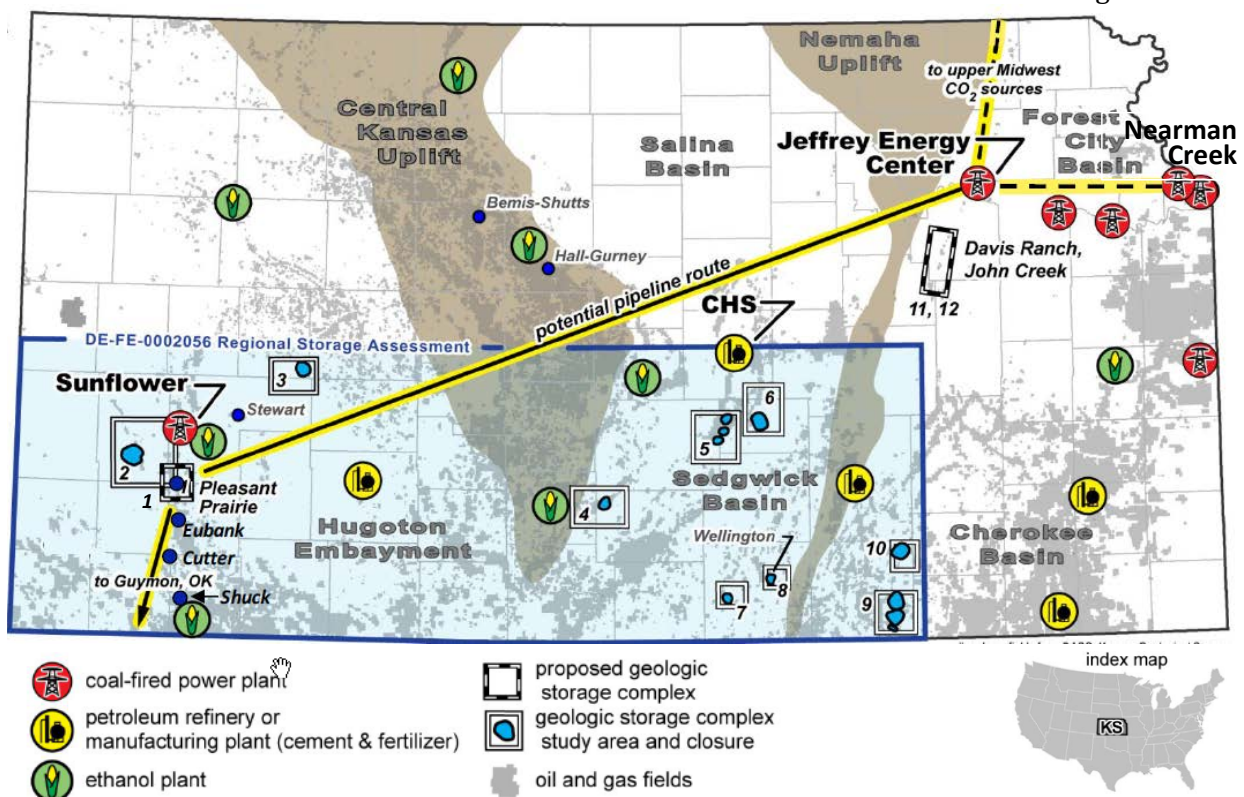

**Figure 1.** Kansas map showing possible CO2 injections sites (numbered 1-12), CO2 sources, possible CO2 pipeline routes, DE-FE0002056 study areas (blue), and oil fields (modified from ICKan SF 424 R&R, 2016).

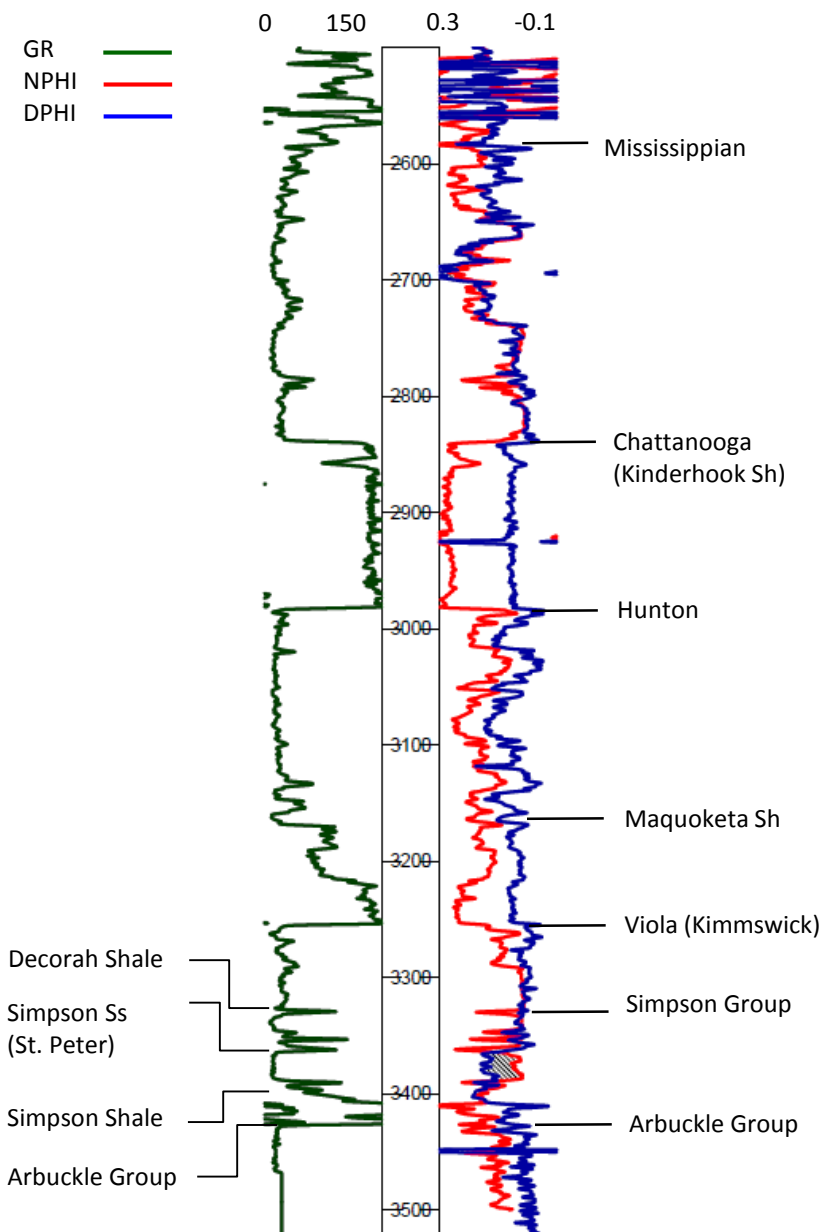
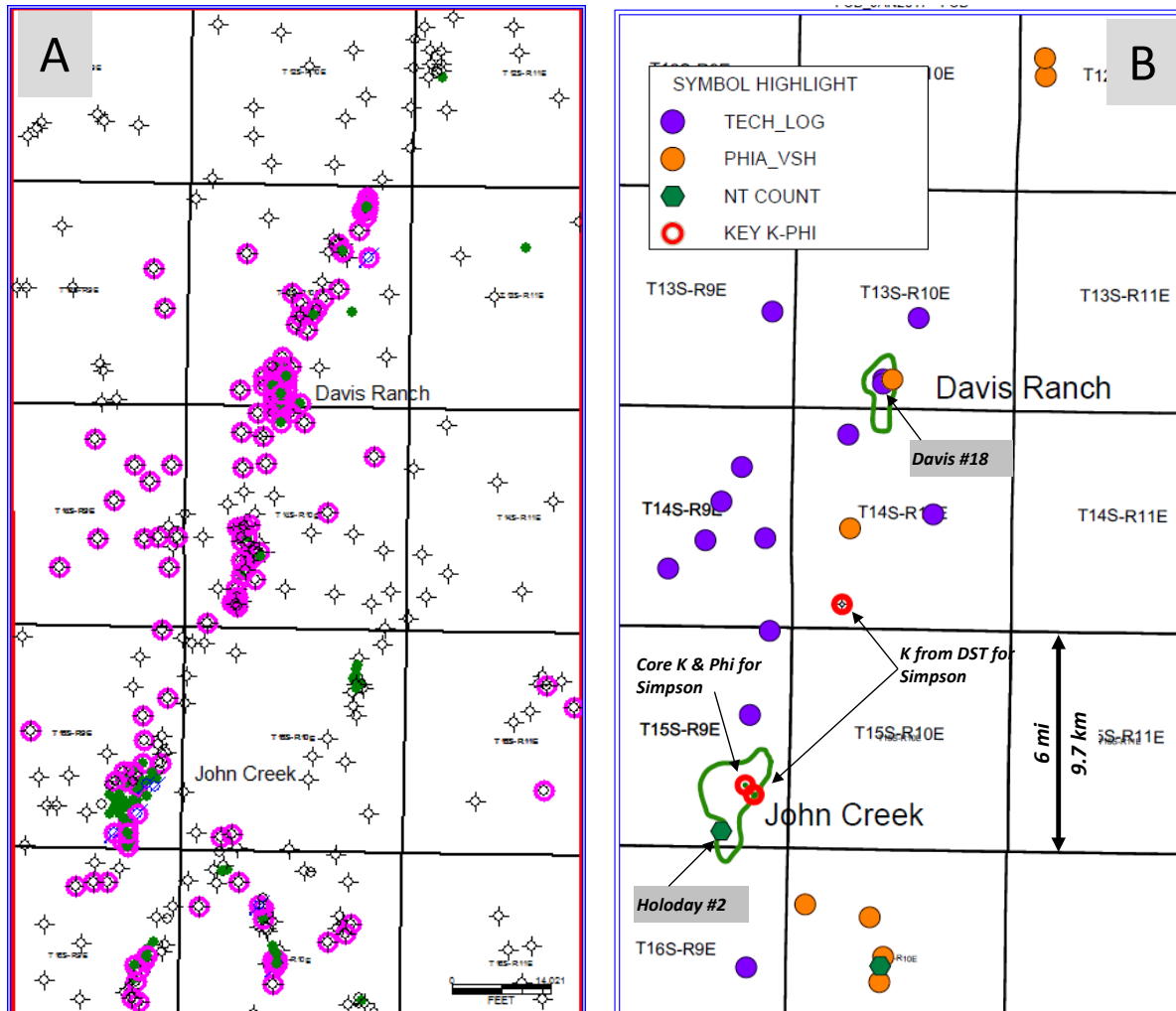

**Figure 2.** Generalized stratigraphic column for the Davis Ranch and John Creek area. Wireline log is from the Conoco, Inc. #1 Fisher Grace well in Morris County, Kansas (API 15-127-2045). Abbreviations included GR – natural gamma ray radiation in API counts, NPHI – neutron porosity expressed in decimal, DPHI – density porosity expressed in decimal.

### STATIC MODEL CONSTRUCTION

A simple, un-faulted 3D static model was built for a 418 mi<sup>2</sup> (1082 km<sup>2</sup>) area (Figure 3) and then smaller areas were cut out of the model for simulation A standard workflow (Figure 4) for building a 3D static model was deployed: 1) gather, prepare and analyze well-scale well data from public sources and operator-partner data, 2) build 2D structure and isopach maps with Geoplus Petra™, 3) develop petrophysical relationships to estimate permeability knowing porosity, 4) build a larger-area 3D static

property model populated with porosity and permeability for the Simpson Sandstone and Arbuckle, 5) upscale the model to reduce cell counts for simulation, and 6) cut out and export smaller field-scale models for simulating the two fields.



**Figure 3.** Davis Ranch and John Creek modeled area. A. 518 wells in the model with raster image logs available for 145 wells (circled). B. Solid-fill symbols are wells with digital logs (25) and the open circles are wells with Simpson Sandstone permeability estimated from drill stem tests (2) and core permeability (1).

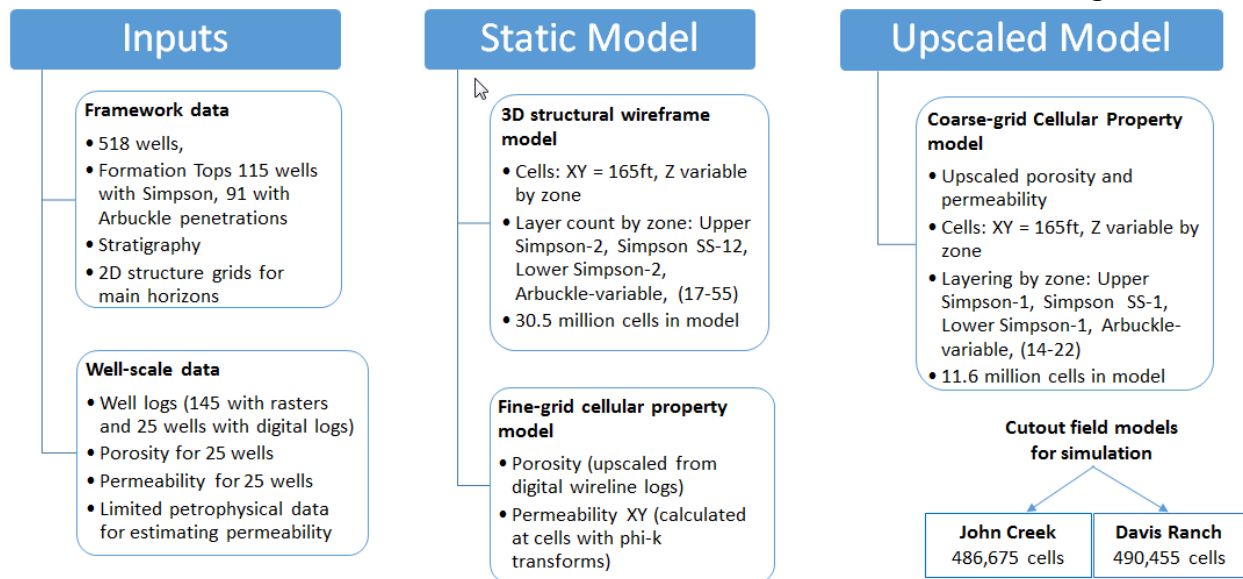

**Figure 4.** Workflow diagram describing data utilized and fine and coarse grid model statistics.

### Data collection and analysis

The data for the static model was collected from the Kansas Geological Survey and Robert F. Walters Digital Library. Model framework and well-scale data was gathered in the form of well header information (e.g. operator information or well name and number), locations, formation tops, and wireline logs in the form of image files. The data was then analyzed in Petra™ geologic software application.

There are 518 wells in the model area (Figure 3). Of these, 387 wells contain formation top data including manually picked tops from the depth-calibrated wireline log images (rasters) at 145 wells. Because the Viola is the main producing horizon in the study area, the deeper Simpson Sandstone is only locally productive, and the Arbuckle is non-oil bearing, most wells stop in the Viola. Thus, fewer tops are available for mapping the deeper horizons (Table 1). Figures 5a through 5f illustrate the distribution of wells with tops by formation in descending order. Figure 3 identifies the wells with rasters and Figure 4 identifies the 25 wells with digital logs used to model porosity and permeability.

Formation Top	Count
Any Formation	387
Hunton	130
Viola	358
Decorah	77
Upper Simpson Group	77
Simpson Sandstone	115
Lower Simpson Group	55
Arbuckle	91
Base Arbuckle (or est. Base Arb.)	11

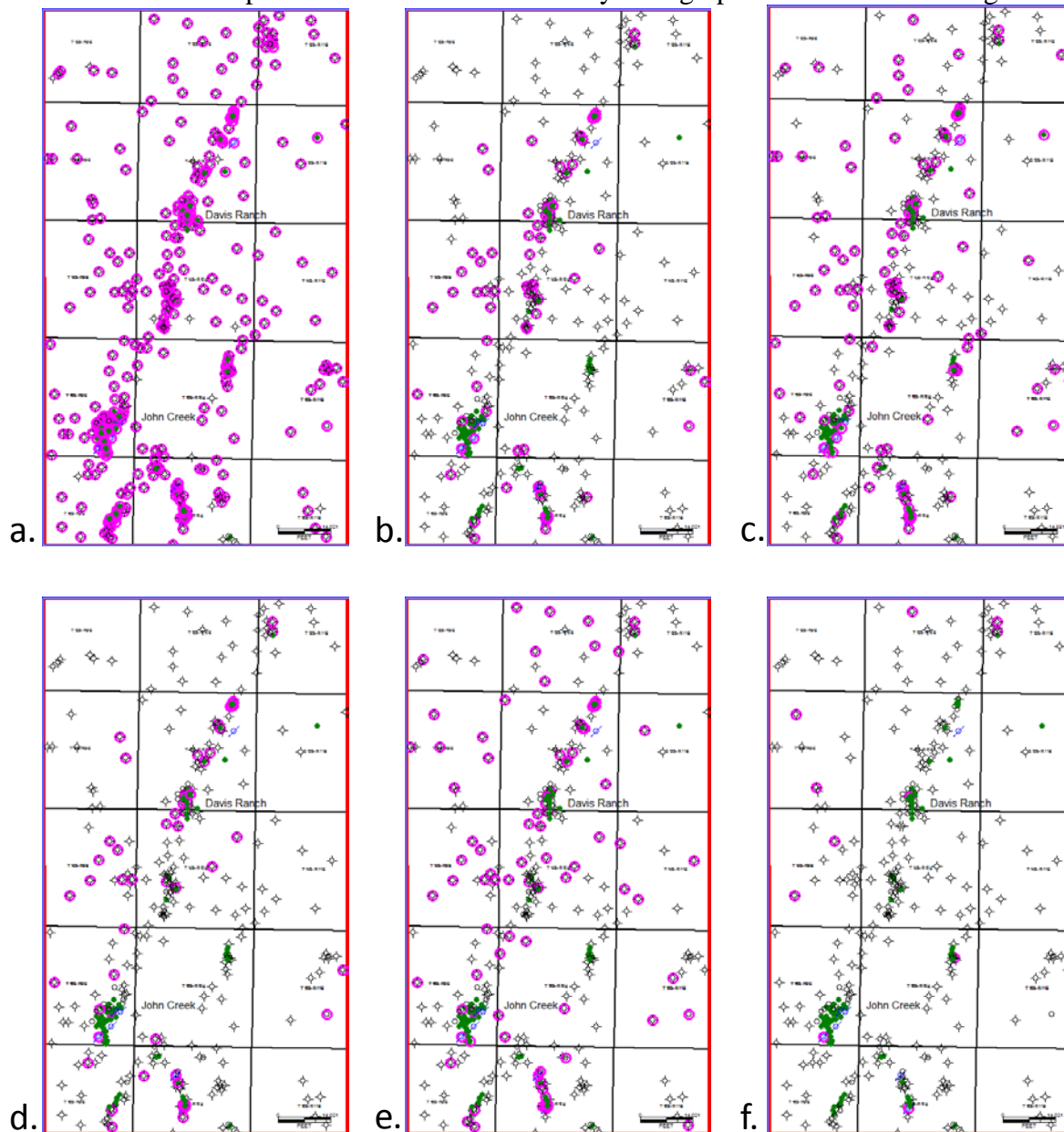
**Table 1.** Formation tops available in modeled area by stratigraphic zone in descending order.**Figure 5.** Formation tops available in the modeled area. a. Viola 358, b. Upper Simpson Group 77, c) Simpson Sandstone 115, d. Lower Simpson Group 55, e. Arbuckle 91, f. Base Arbuckle or estimated Base Arbuckle 11.

## 2D Structure Mapping

2D Structure Maps were generated in Petra™ and then exported to Petrel™ for 3D modelling. A formation structure map (grid) for the Viola Formation (most tops control), was gridded from the tops data and manually-inputted control points using a minimum curvature surface style with no faults. The structural surfaces for the zones below the Viola were generated by using grid-to-grid

operations. Isopachs were gridded downward between tops to be mapped. In a sequential manner, the isopach grids were subtracted from the overlying structural grid, beginning with the Viola (structure - isopach = next lower structural grid), until the structure of all targeted injection zones and seal intervals were gridded. Bounding structural surfaces for the Viola, Upper Simpson, Simpson Sandstone, Lower Simpson, and Arbuckle zones were generated by this process. The project grids, well header information, tops data, and digital porosity logs, were checked for quality and then exported from Petra™ to Petrel™.

### **3D High Fine-grid Cellular Structural Model**

A 3D skeletal grid was created in the model with four zones Upper Simpson, Simpson Sandstone, Lower Simpson, and Arbuckle zones, bounded by 2D surfaces generated in Petra™. X-Y cell dimensions were set at 165X165 ft. The zones were layered as described below, to form cell z-values along the pillars of this skeletal grid.

#### *Fine Grid Layering*

The zones were layered in the model and are summarized in Table 2, and presented in Figure 6. The Simpson zones were layered proportionally and as a result cell height varies depending on zone thickness. The Arbuckle was layers were set at 4 ft. thicknesses from the base Arbuckle and as a result cell height is generally fixed to 4 ft., with the number of layers in the model varying dependent on the zone thickness. The cell height is “generally” fixed because while the layer/cell height does not vary from 4’, the layers crop out against the overlying Simpson Group (Figure #), and a resulting number of cells have cell heights less than 4’ thick. The Simpson zones layered proportionally consist of the Upper Simpson Group (2 layers), Simpson Sandstone (12 layers), and the Lower Simpson Group (2 layers). The Arbuckle, layered in 4 ft. thick layers from the base Arbuckle, has 17-55 layers (average of 31 layers). The number of layers, number of cells, and cell height by zone for the fine and coarse cellular model are summarized on Table 2.



<b>a) Fine Model</b>			
	<b>Layers</b>	<b>Cell Height (ft)</b>	<b># of cells in model (millions)</b>
Upper Simpson Group	2	8.8-17.01 (avg = 13.66)	0.86
Simpson Sandstone	12	1.44-6.80 (avg = 3.78)	5.2
Lowers Simpson Group	2	3.79-15.83 (avg = 8.46)	0.86
Arbuckle	17-55 (avg = 31.36)	0-4 (avg = 3.93)	23.6
<b>Totals for Model</b>	33 - 71	na	30.5

<b>b) Coarse Model</b>			
	<b>Layers</b>	<b>Cell Height (ft)</b>	<b># of cells in model (millions)</b>
Upper Simpson Group	1	17.59-34.02 (avg = 27.32)	0.43
Simpson Sandstone	3	5.77-27.20 (avg = 15.11)	1.3
Lower Simpson Group	1	7.57-31.66 (avg = 16.92)	0.43
Arbuckle	7-22 (avg = 12.8)	0-10 (avg = 9.59)	5.5
<b>Totals for Model</b>	12-27	na	7.6

**Table 2.** Static model statistics for fine- and coarse-grid models, layering, cell height, and cell count by zone.

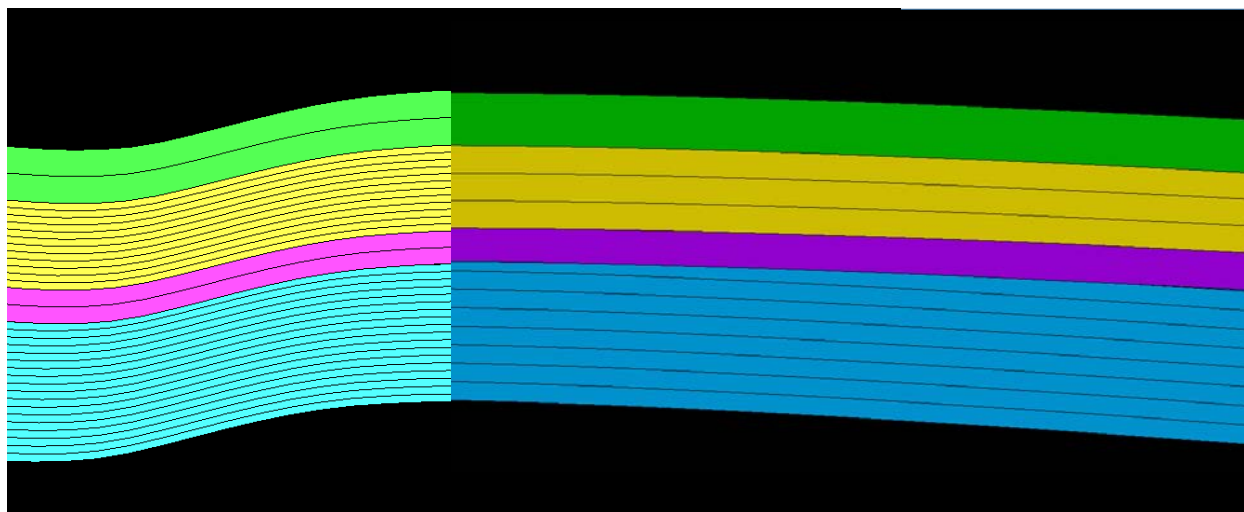

**Figure 6.** Skeletal grid layering by zone in the fine grid (left) and coarse grid (right).

### *Petrophysical Properties*

In the fine-grid model, porosity from 25 digitized wireline logs was upscaled to layer scale using an arithmetic average. The Schlumberger Gaussian random function simulation<sup>®</sup> method was used to model zone porosity between wells with wireline logs. The simulation used a default spherical variogram model with a sill of 0.99 and range of 500 ft. Porosity distribution at the well log scale, upscaled to the cells at the well and the full model are very similar as illustrated in Figure 7.



Permeability was then calculated at each cell using porosity-to-permeability transform functions described in the petrophysics section. Permeability for the Simpson formation was calculated using the exponential function where porosity units are in percent:

$$(3.1549) e^{(\text{Porosity} * 0.2021 * 100)}$$

Permeability of the Arbuckle was calculated using the power function where porosity is in decimal fraction:

$$(840.11) * (\text{Porosity})^{(1.3289)}$$

Permeability of the seals (upper and lower Simpson Group) were assigned .000001 mD for simplicity during simulation. Porosity and permeability for both fields are illustrated in Figure 8.

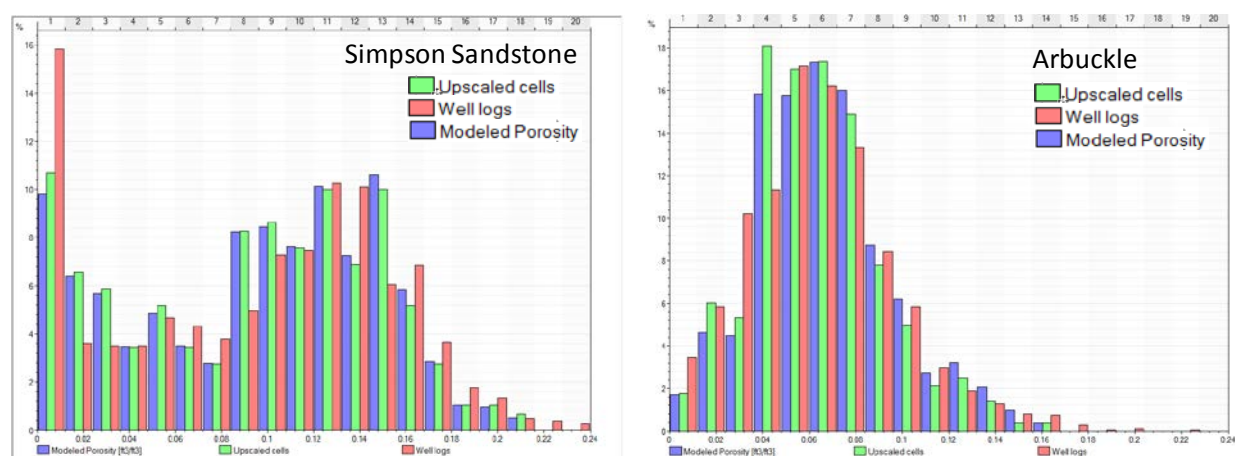

**Figure 7.** Porosity at three scales for the Simpson Sandstone and Arbuckle zones in the fine-grid model. Y-axis (% of volume) is from 0-16% for the Simpson and 0-18% for the Arbuckle. X-axis (porosity in decimal fraction) ranges from 0-0.24 in both charts.

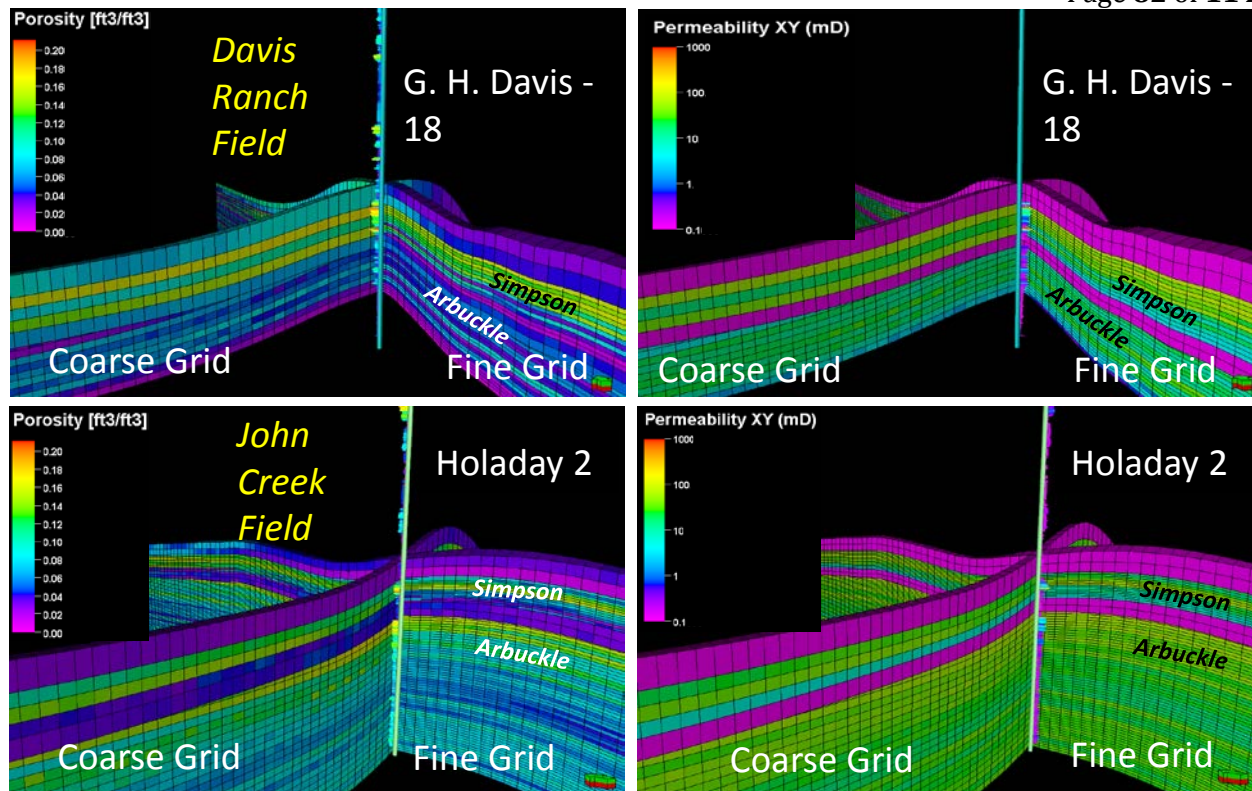

**Figure 8.** Intersecting cross sections demonstrating porosity and permeability Fence Diagrams of the Fine and Coarse Grid at key wells. VE=10.

## Coarse-Grid Cellular Model for Simulation

### *Coarse Grid Layering*

The Simpson zones were layered proportionally and consist of the Upper Simpson Group (1 layers), Simpson Sandstone (3 layers), and the Lower Simpson Group (1 layers). The Arbuckle, layered in 10 ft. thick layers from the base Arbuckle, has 7-22 layers (average of 12.8 layers). The number of layers, cell height, and number of cells by zone for the coarse cellular model are summarized in Table 2.

### *Petrophysical properties upscaled to coarse-grid model*

Porosity was upscaled to the coarse-grid model using volume-weighted arithmetic averaging algorithm. Permeability was upscaled using volume-weighted geometric averaging. Histograms of porosity in the Simpson Sandstone and Arbuckle for the coarse and fine grid models are compared in Figure 9.

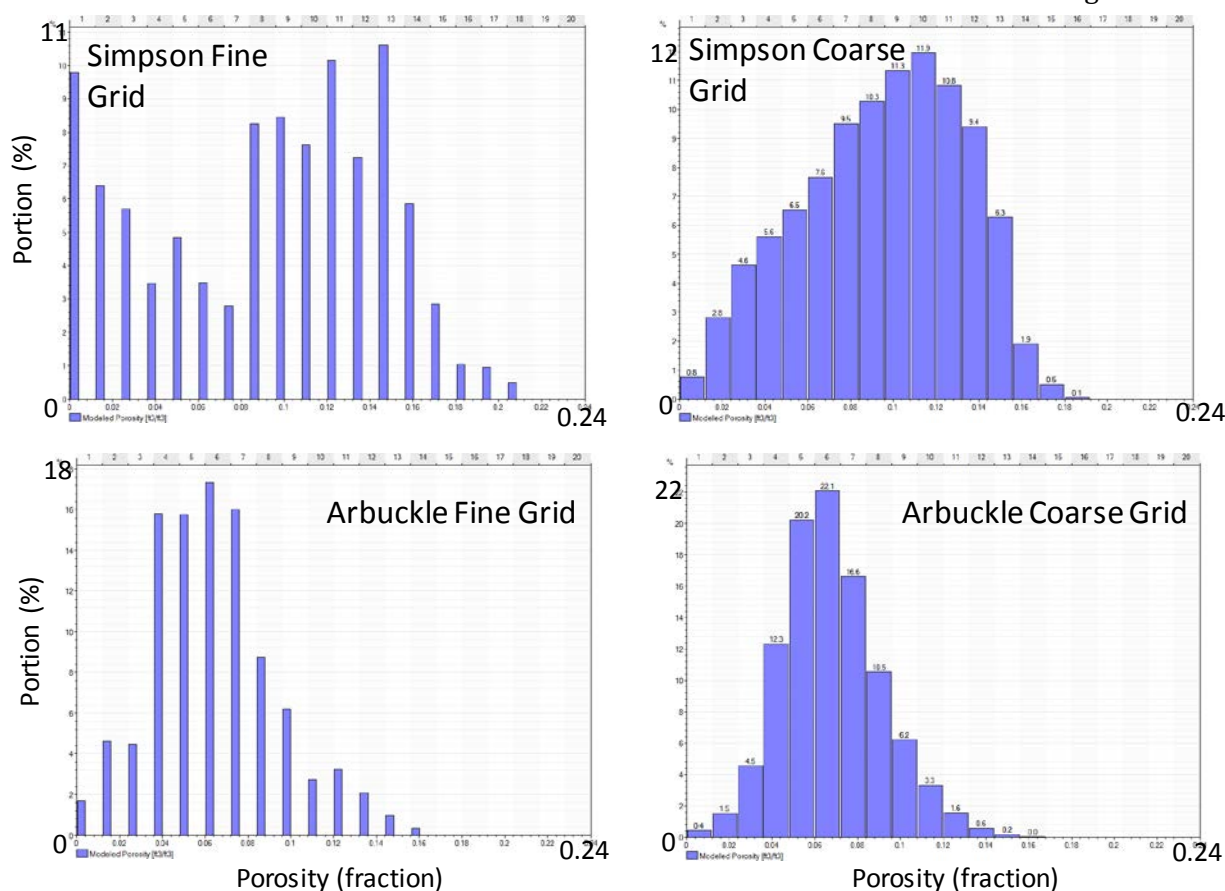

**Figure 9.** Porosity histograms for the Simpson and Arbuckle zones for the fine and coarse grid models.

**Volumetric calculations**

This section, and Table 3, summarizes the results of the volumetric calculations for the Simpson Sandstone and Arbuckle in the John Creek and Davis Ranch fields.

A spill point at sea-level -1970 was identified for the Simpson Sandstone of the Davis Ranch. The corresponding volume of pore space in the resulting closed structure within the Simpson Sandstone was calculated at 466,010,389 cubic feet.

A spill point at sea-level -2035 was identified for the Arbuckle of the Davis Ranch. The corresponding volume of pore space in the resulting closed structure within the Simpson Sandstone was calculated at 213,354,154 cubic feet.

A spill point at sea-level -1850 ft. was identified for the Simpson Sandstone of the John Creek. The corresponding volume of pore space in the resulting closed structure within the Simpson Sandstone was calculated at 432,322,891 cubic feet.

A spill point at sea-level -1915 ft. was identified for the Arbuckle of the John Creek. The corresponding volume of pore space in the resulting closed structure within the Simpson Sandstone was calculated at 583,916,632 cubic feet.

The total combined pore volume calculated in the Simpson Sandstone and Arbuckle of both fields is 1,695,604,066 cubic feet.

<b>Davis Ranch</b>				
	<b>Spill Point (SSTVD)</b>	<b>Bulk volume (billion ft<sup>3</sup>)</b>	<b>Pore Volume (billion ft<sup>3</sup>)</b>	<b>Pore RB (million)</b>
<b>Simpson Sand</b>	-1970	3.95	.466	83
<b>Arbuckle</b>	-2035	4.55	.213	38
<b>John Creek</b>				
<b>Simpson Sand</b>	-1850	3.85	.432	77
<b>Arbuckle</b>	-1915	6.18	.584	104
<b>Totals</b>				
<b>Simpson Sand</b>		7.8	0.898	160
<b>Arbuckle</b>		10.73	0.797	142
		<b>18.53</b>	<b>1.695</b>	<b>302</b>

**Table 3.** Modeled reservoir pore volumes by zone and field, and combined.

### Field Extraction and Export

In both the Davis Ranch and John Creek fields, an irregular boundary larger than the modelled spill point was selected, and the two models were cut to make two separate models (Figures 10 and 11). The two models were then exported under Rescue format.

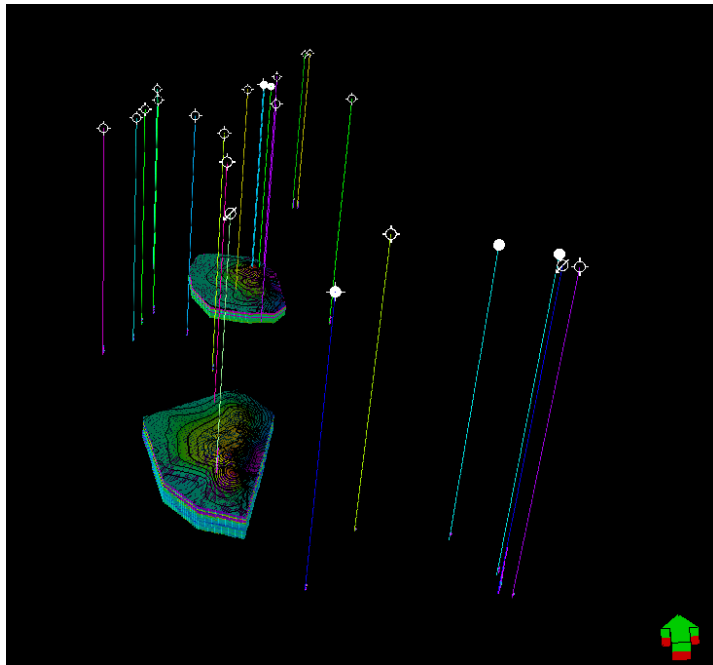

**Figure 10.** John Creek (lower, south) and Davis Ranch model extraction in relation to the 25 wells with digitized log data. Vertical exaggeration = 10X.

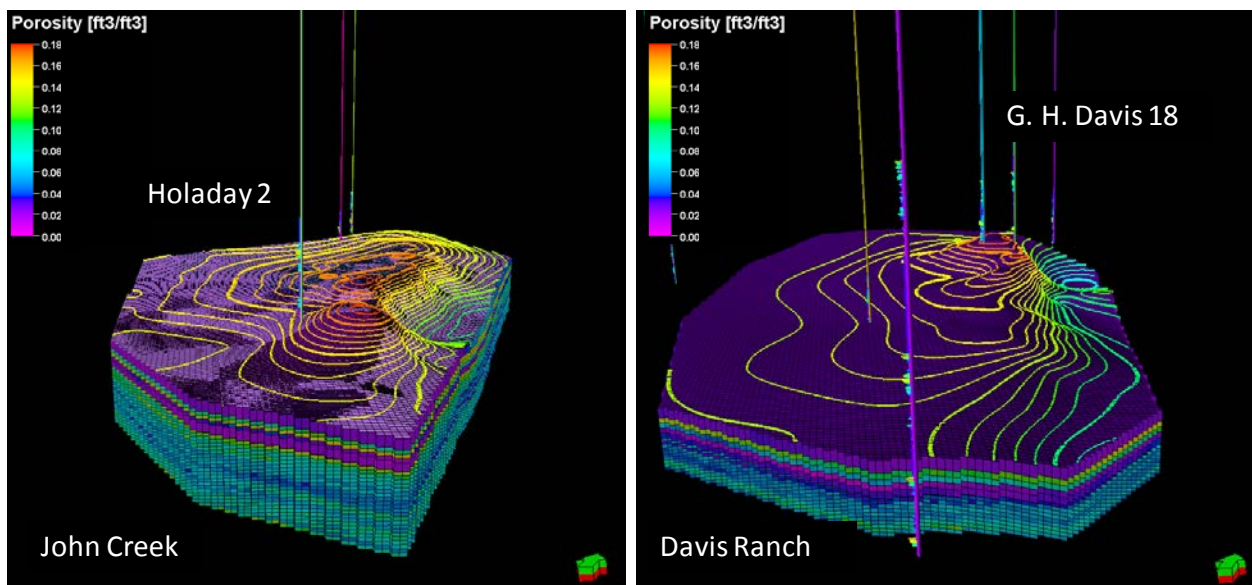

**Figure 11.** John Creek (lower, south) and Davis Ranch model extraction with key 25 wells. Vertical exaggeration = 10X, contours = 10 ft.

## PETROPHYSICS

### Porosity from wireline logs

Although petrophysical work in the study area was constrained by very limited data we are confident the main properties, porosity and permeability, are well characterized in the Simpson and Arbuckle. Because most of the drilling took place in the 1950s there is a limited number wells with modern logs (neutron and density porosity, GR and resistivity) that penetrated the target injection zones. The distribution of twenty-three wells fitting that criteria are shown in Figure 3 and denoted Tech\_Log and Phi\_Vsh. Total porosity was calculated using Techlog™ multi-mineral module for 15 wells (purple dots) and average neutron-density porosity corrected for shale volume was used for the other eight wells (orange dots). Neutron count logs from two wells were calibrated for porosity in two wells, including a key well, the Holoday #2, the deepest penetration in the Arbuckle (216 ft). Simpson average porosity is about 13% v/v and Arbuckle has a mean porosity of 5% v/v.

### Permeability estimation

Two independent empirically-based methods for estimating permeability in the Simpson were deployed, with both having similar results (Table 4). For the Arbuckle, two different (from the Simpson) independent, empirically-based methods were evaluated with similar results. A third method, described below, yielded lower permeabilities and was not considered. Transform functions for estimating permeability were derived from the data for the Simpson and Arbuckle (Figure 6) and applied to the log-calculated porosity in the 25 key wells at the half-foot scale.

	Average K (mD)	h (ft)	Kh (mD-ft)
<b>Simpson</b>			
Core Analysis (Lucy B Kiefer 4)	105	23	2415
DST Buildup (Vincent 1)	56	25	1400
DST Buildup (Eldridge 4))	182	25	4550
<b>Arbuckle</b>			
Injectivity Index	18	198	3564
Neural Network (Holoday 2)	13	198	2574
Neural Network (Davis 18)	19	60	1140
Neural Network (Warren 1)	27	64	1728

**Table 4.** Permeability for the Simpson Sandstone and the Arbuckle. Abbreviations include K – permeability, h – height, mD – millidarcies, and DST – drill stem test.

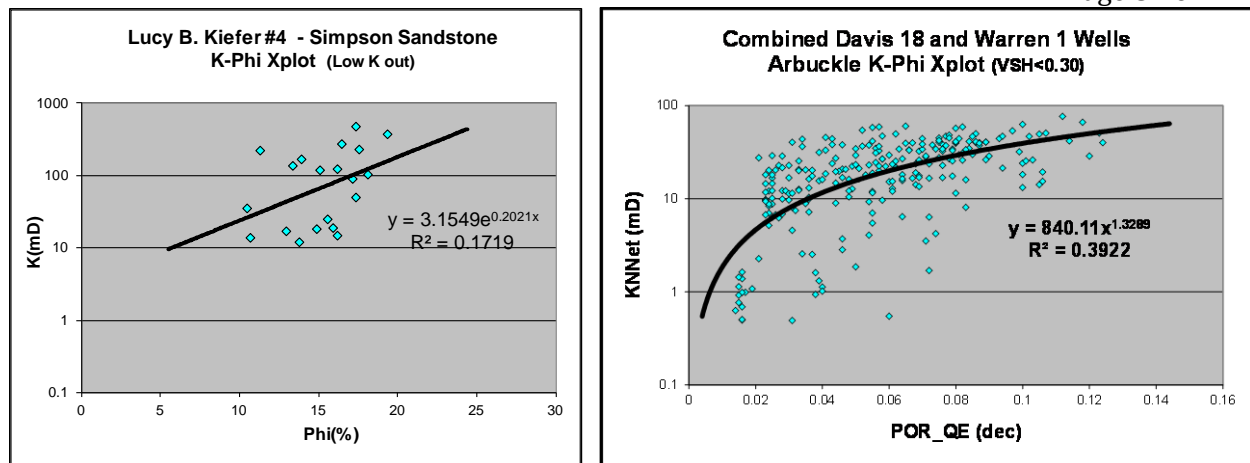

**Figure 6.** Porosity –Permeability transform equations by regression for Simpson Sandstone and Arbuckle. Permeability for the Arbuckle was estimated using a neural network approached described in a later sub-section.

### *Simpson permeability*

Two types of data for permeability in the Simpson were available, conventional core analysis and drill stem tests (DST) (locations in Figure 3). Routine core data was available for Simpson group in Lucy B. Kiefer #4 Core permeability was plotted against core porosity for the Simpson sand and the exponential function was fit to the data (Figure 6).

DST in three wells were digitized and analyzed in Simpson sand. These wells are: Lucy B Kiefer 4 (well with core data), Vincent 1 and Eldridge 4. Lucy B Kiefer #4 well is next to the Vincent 1 well in the John Creek field, and the Eldridge 4 is six miles to the northeast (Figure 3). Permeability estimates for the three Simpson DSTs are summarized in Table 5.

Well name	K	h	Kh	Pressure
	mD	ft	mD.ft	psia
<b>Lucy B</b>	75	23	1726	1181
<b>Vincent 1</b>	55.6	25	1391	1093
<b>Eldridge 4</b>	134	25	3350	1052

**Table 5.** DST analysis results for Lucy B Kiefer 4, Vincent 1 and Eldridge 4.

DST in Lucy B Kiefer 4 and Vincent 1 were old (1950s vintage) and generally of poor quality. The more recent DST data for the Eldridge 4 may be more reliable. Raster images of the older, unscaled DST charts were digitized and time and pressure axes were estimated as best possible. The Eldridge 4, a more recent DST was of high quality and results are considered accurate. Average permeability from core in Permeability in Simpson ranges from 55-134 mD from DST results, Table 5. DST analysis plots are in Figures 7, 8 and 9.



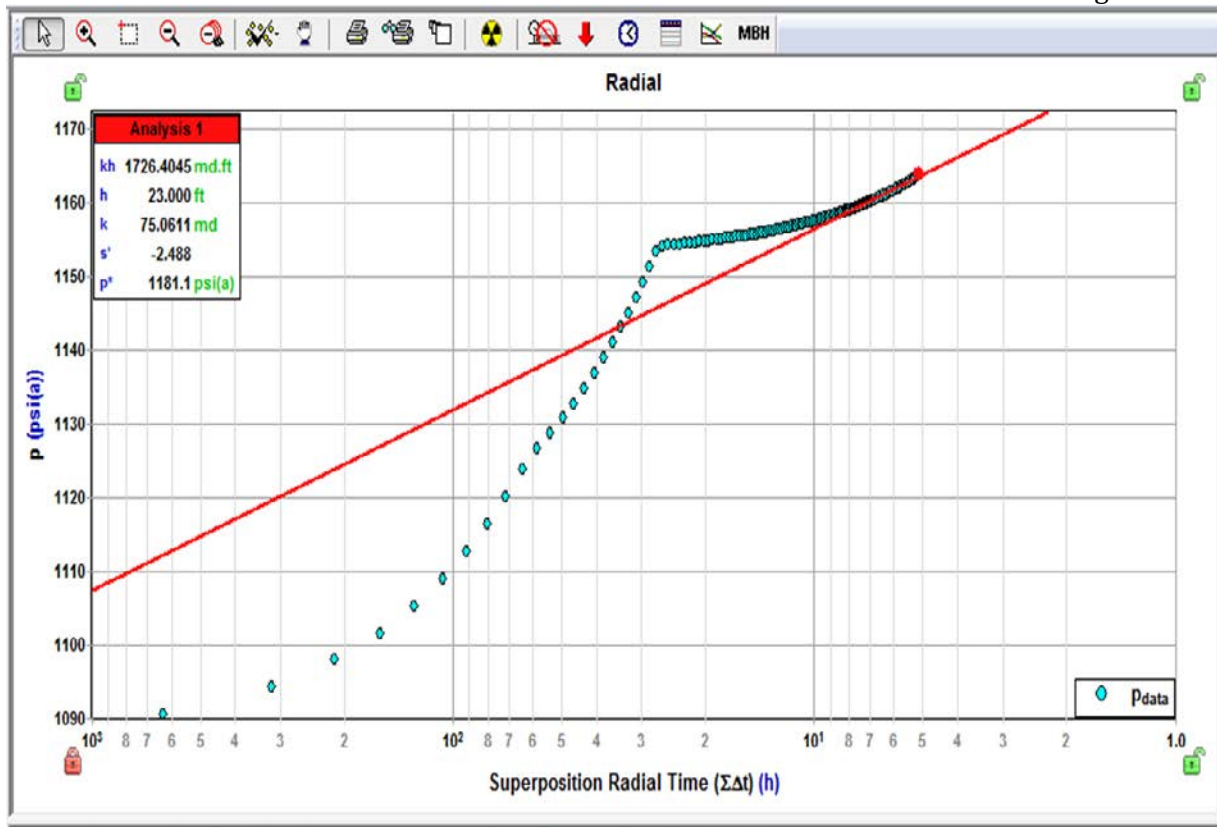

Figure 7. DST analysis in Lucy B Kiefer #4

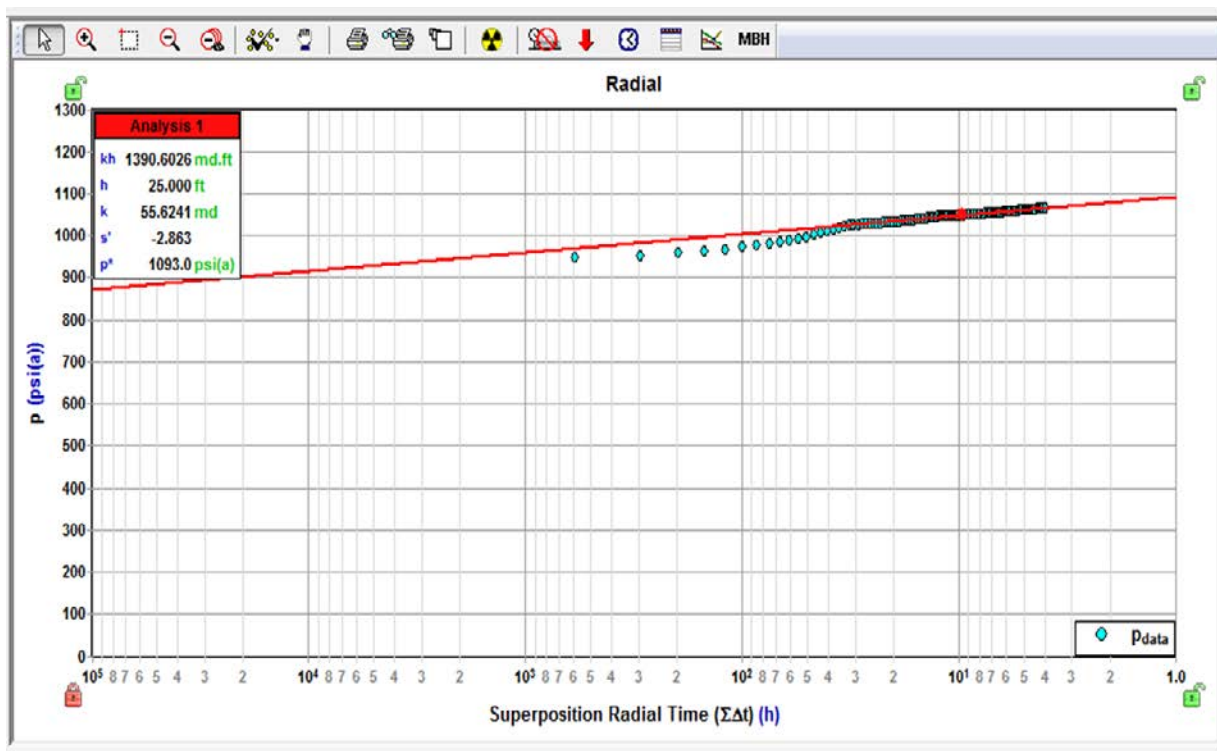

Figure 8. DST analysis in Vincent 1



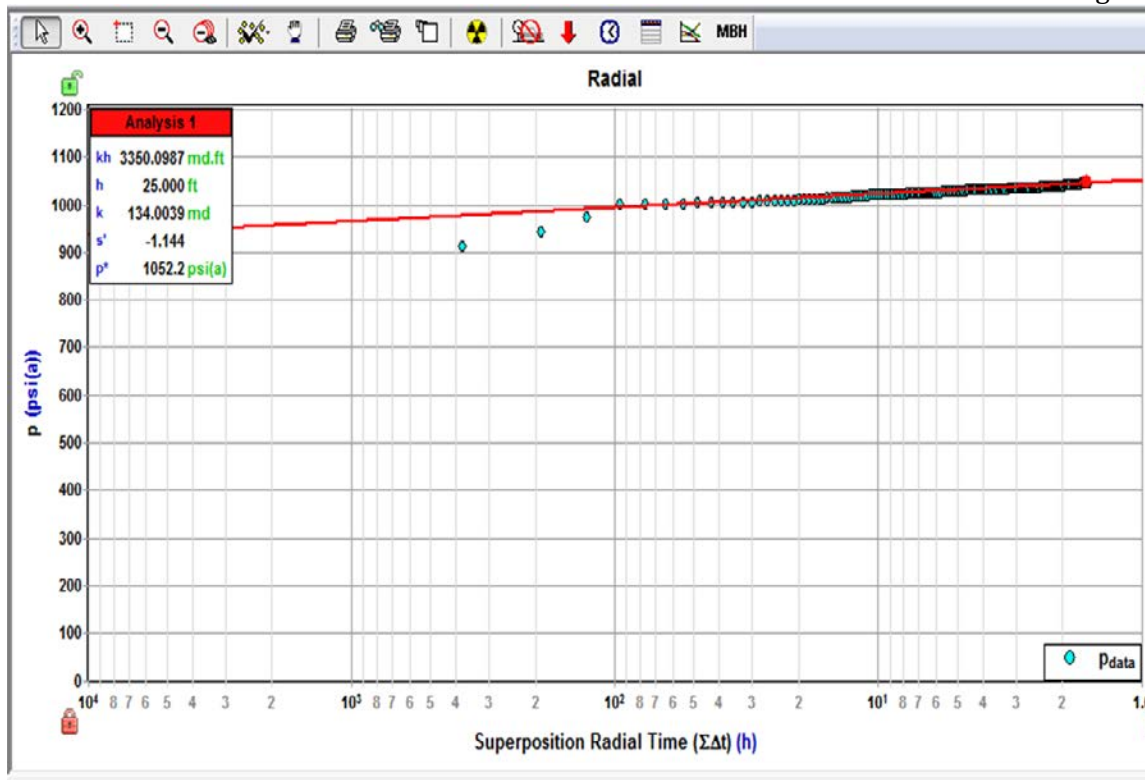

Figure 9. DST analysis in Eldridge 4

*Arbuckle permeability*

Permeability estimates for the Arbuckle were derived from two different approaches than they were from the Simpson, one based on local data (water injection in the Holoday 2 well), and the other utilizing core analysis and NMR data from the Arbuckle in a distant well. There is no Arbuckle core data available in the region.

*Arbuckle permeability by injectivity index*

Permeability was determined for the Holoday 2, a saltwater disposal well in the Arbuckle where 1600 barrels of brine are disposed daily in 198 ft of open hole, on a vacuum. Having the injection rate, estimated bottom hole injection pressure and static pressure, an injectivity Index was calculated. The injectivity Index was then used in the Darcy equation of radial flow and permeability was calculated for 198 ft open hole in the Arbuckle. Three permeability estimates were calculated by varying the skin factor are illustrated in Table 6.

Skin	Permeability, mD
-4	24.34
-5	18.08
-6	11.82

Table 6. Calculated average permeability for 198 ft of open hole in Holoday 2 by Injectivity Index.

*Arbuckle permeability by correlations with distant core and NMR data*

The second method for estimating permeability was using a neural network function trained on Arbuckle NMR-derived permeability data for the Berexco LLC #1-32 KGS Wellington well, a science well in the small-scale field demonstration project (DE-FE0006821) located approximately 120 miles southwest of this study area. Data from Wellington field was used for training and validation (blind test) where core data and NMR permeability were available. 1-32 was used for training and 1-28 was the validation well. The model and training dataset was limited to the Arbuckle. After a satisfactory result, the model was applied to Holiday 2 and calculated average permeability for the 198ft open interval is about 12.6 mD, Figure 10. This is a bit lower than the 18 mD average based on injectivity for the interval.

The Neural Network approach defined above was used on two other wells with modern log suites, the Davis 18 and Warren 1. Average permeability calculated in this manner for the Arbuckle interval in these two wells is 18 and 26 Md respectively. Well plots from TechLog are provided in Figures 11 and 12.

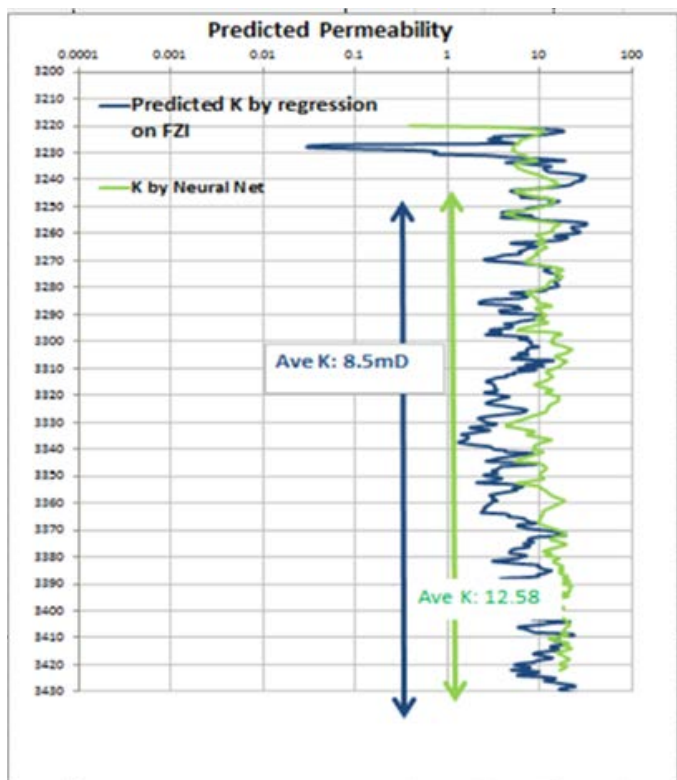

Figure 20. Permeability in Holiday 2 by Neural Network and regression

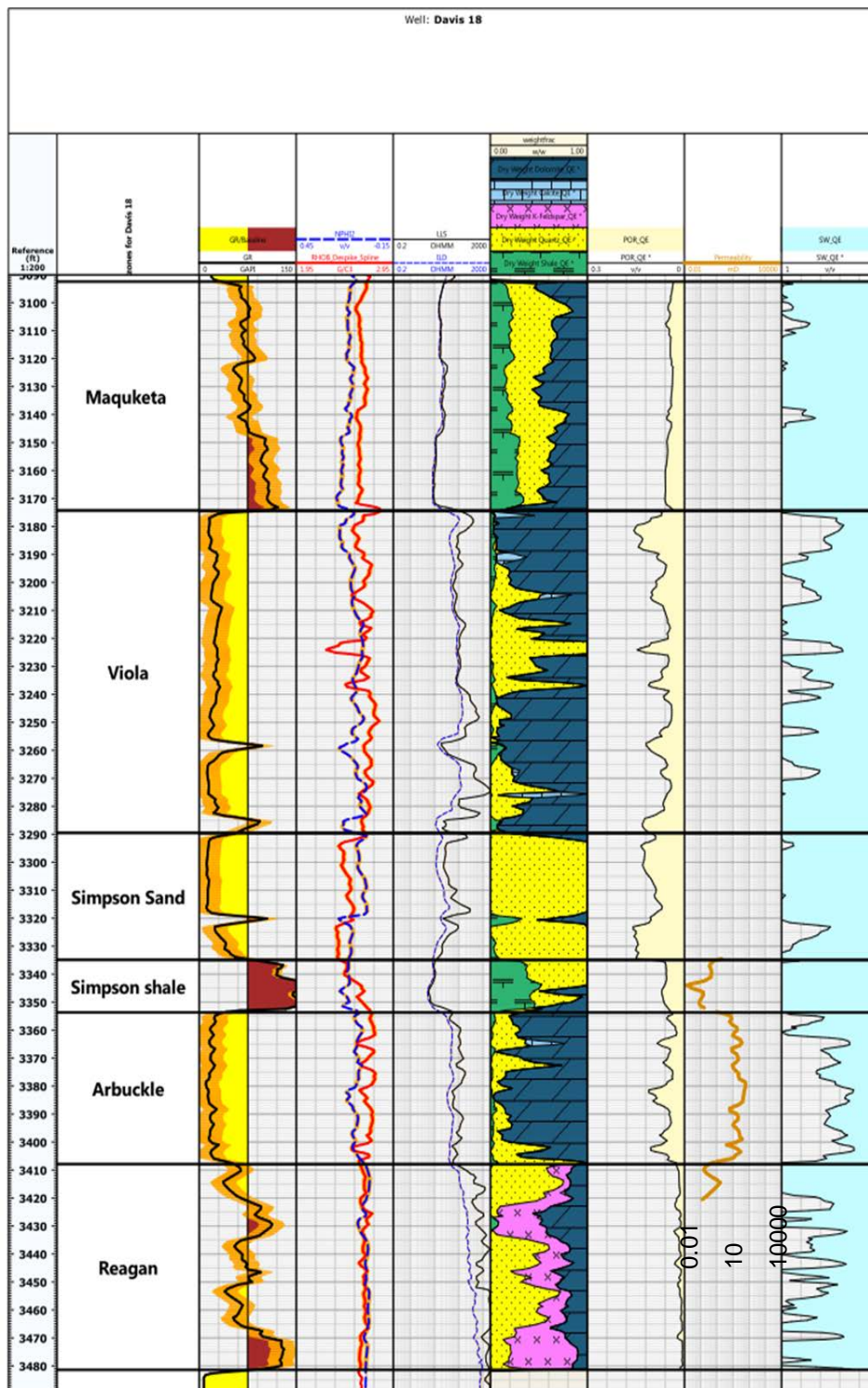

Figure 11. Log analysis and permeability by Neural Network in Davis 18. Permeability is in the second track from the right. Log scale ranges from 0.01 to 10,000 mD.

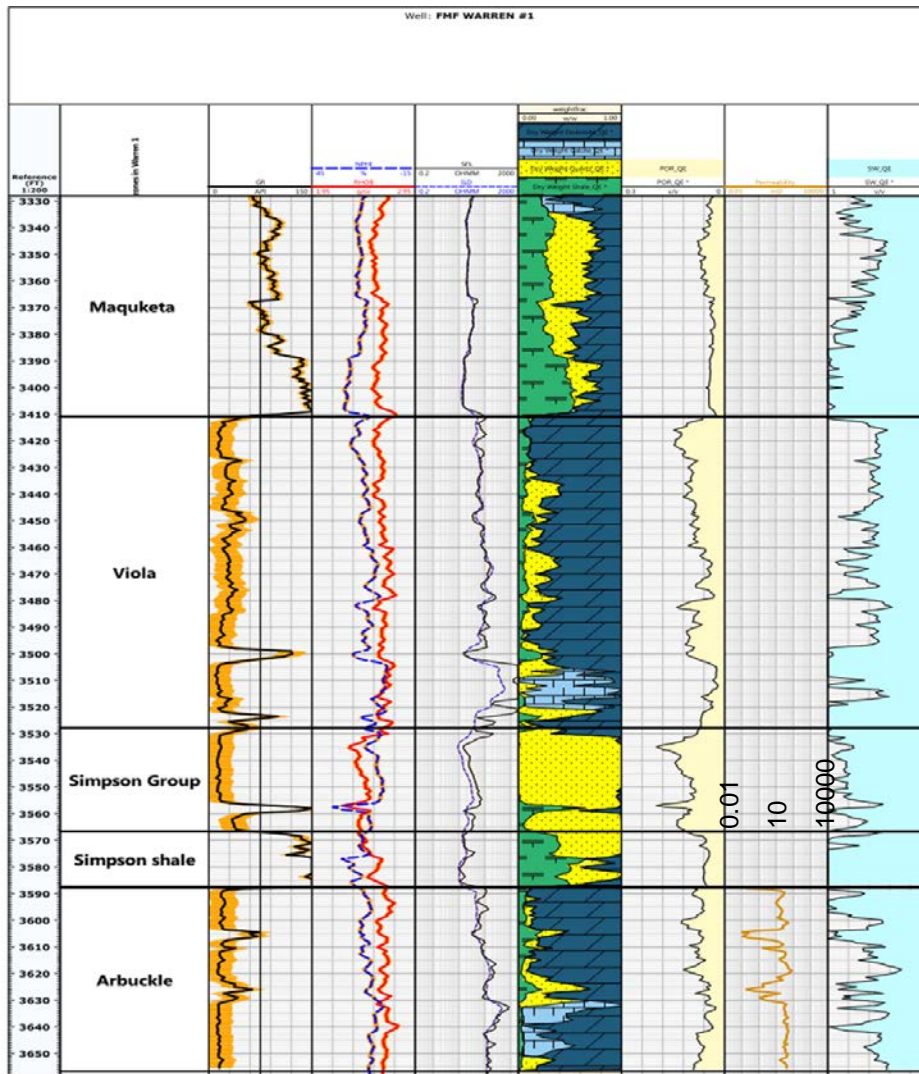

Figure 12. Log analysis and permeability by Neural Network in Warren 1. Permeability is in the second track from the right. Log scale ranges from 0.01 to 10,000 mD.

*Arbuckle permeability by Flow Zone Indicator*

In a third approach permeability was calculated by regression using well 1-32 to predict the dependent variable Flow Zone Indicator (FZI) and therefore permeability from FZI. Given the independent variables of GR, Porosity and conductivity, relationship between the dependent variable FZI and independent variables were estimated and the equation was used to predict FZI in Well Holiday 2. Permeability was calculated based on FZI and average estimated permeability is 8.5 mD, Figure 10. This is about the 18 mD average based on injectivity for the interval, and this approach was not considered further.

### *Estimating Arbuckle permeability in the study area wells*

Despite the distance between the Wellington core and NMR data and the study area, the Arbuckle permeability estimates using the Neural Network approach were like that derived by the local injection data. Rather than applying the Neural Network methodology to the entire 25 well data set, a shortcut was taken. A porosity-permeability transform was developed by cross-plotting the porosity with the Neural Network predicted permeability for the Davis 18 and Warren 1 wells (Figure 6). Average permeability calculated using this transform is 14 mD for the Holoday 2 well, slightly higher than predicted by the neural network directly (13 mD), Davis. Permeability in the Arbuckle for the other 22 wells was estimated using the transform function.

## **DYNAMIC MODELING OF CO<sub>2</sub> INJECTION AT DAVIS RANCH AND JOHN CREEK SITES**

The key objectives of the dynamic modeling were to determine the volume of CO<sub>2</sub> stored, resulting rise in pore pressure and the extent of CO<sub>2</sub> plume migration in the two fields in the Forest City Basin storage complex. An extensive set of computer simulations were conducted to estimate the potential impacts of CO<sub>2</sub> injection in the Arbuckle injection zone.

The reservoir simulations were conducted using the Computer Modeling Group (CMG) GEM simulator. GEM is a full equation of state compositional reservoir simulator with advanced features for modeling the flow of three-phase, multi-component fluids and has been used to conduct numerous CO<sub>2</sub> studies (Chang et al., 2009; Bui et al., 2010). It is considered by DOE to be an industry standard for oil/gas and CO<sub>2</sub> geologic storage applications. GEM is an essential engineering tool for modeling complex reservoirs with complicated phase behavior interactions that have the potential to impact CO<sub>2</sub> injection and transport. The code can account for the thermodynamic interactions between three phases: liquid, gas, and solid (for salt precipitates). Mutual solubilities and physical properties can be dynamic variables depending on the phase composition/system state and are subject to well-established constitutive relationships that are a function of the system state (pressures, saturation, concentrations, temperatures, etc.). The following assumptions govern the phase interactions:

- Gas solubility obeys Henry's Law (Li and Nghiem, June 1986)
- The fluid phase is calculated using Schmit-Wenzel or Peng-Robinson (SW-PR) equations of state (Soreide-Whitson, 1992)
- Changes in aqueous phase density with CO<sub>2</sub> solubility, mineral precipitations, etc., are accounted for with the standard or Rowe and Chou correlations.
- Aqueous phase viscosity is calculated based on Kestin, Khalifa, and Correia (1981).

### **Initial reservoir conditions and simulation constraints**

The initial conditions specified in the reservoir model are specified in Table 7. The simulations were conducted assuming isothermal conditions. Although isothermal conditions were assumed, a thermal gradient of 0.008 °C/ft was considered for specifying petrophysical properties that vary with layer depth and temperature such as CO<sub>2</sub> relative permeability, CO<sub>2</sub> dissolution in formation water, etc. The original static pressure in the injection zone was set to reported field test pressures and the Arbuckle pressure gradient of 0.48 psi/ft was assumed for specifying petrophysical properties. Perforation zone was set at all permeable layers in Simpson and Arbuckle reservoirs. Injection rate was assigned according to maximum calculated based on well tests and reservoir properties.



	John Creek	Davis Ranch
Temperature	41 °C (106 °F)	38 °C (100 °F)
Temperature Gradient	0.008 °C/ft	0.008 °C/ft
Pressure	1,160 psi (7.99 MPa)	1,200 psi (8.27 MPa)
TDS	30 g/l	24 g/l
Perforation Zone	Simpson, Arbuckle	Simpson, Arbuckle
Injection Period	25 years	25 years
Injection Rate	2,100-3,000 MT/day	350-940 MT/day
Total CO <sub>2</sub> injected	21,000,000 MT	3,600,000 MT

**Table 7.** Model input specification and CO<sub>2</sub> injection rates

Physical processes modeled in the reservoir simulations included isothermal multi-phase flow and transport of brine and CO<sub>2</sub>. Isothermal conditions were modeled because the total variation in subsurface temperature in the Arbuckle and Simpson intervals from the top to the base is only slightly more than 3°F (which should not significantly affect the various storage modes away from the injection well), and because it is assumed that the temperature of the injected CO<sub>2</sub> will equilibrate to formation temperatures close to the well. Uniform salinity concentration was assumed. Subsurface storage of CO<sub>2</sub> occurs via the following four main mechanisms: structural trapping, aqueous dissolution, and hydraulic trapping.

Models were optimized for maximum CO<sub>2</sub> storage capacity potential. Three wells completed at Simpson and Arbuckle intervals were introduced in high structural points for both modeled sites. No-flow boundary conditions were specified along the top of the Simpson Formation based on brine chemistry data and other evidence. The lateral boundary conditions were set as an infinite-acting Carter-Tracy aquifer (Dake, 1978; Carter and Tracy, 1960) with leakage. This is appropriate since the Simpson and Arbuckle are open hydrologic systems extending over the Forest City Basin.

The bottom hole injection pressure in the Arbuckle should not exceed 90% of the estimated fracture gradient of 0.75 psi/ft (measured from land surface) based on EPA and KDHE guidelines for UIC Class I & VI wells. Therefore, the maximum induced delta pressure at the top of Simpson and bottom of the Arbuckle Group should be less than 750 psi.

Relative permeability and capillary pressure curves (Figures 19 and 20) were calculated based on a recently patented formula (SMH reference No: 1002061-0002) that relates the end-points. This method and method validation is outlined in more details in Fazelalavi, 2017.

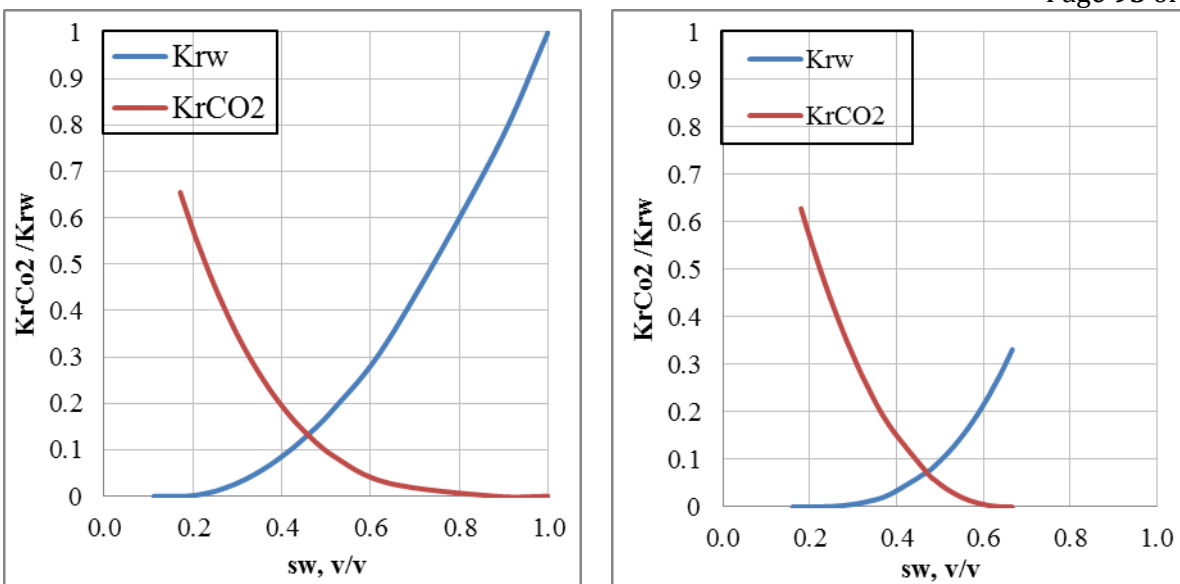

**Figure 19.** Calculated relative permeability for drainage (left) and imbibition (right).

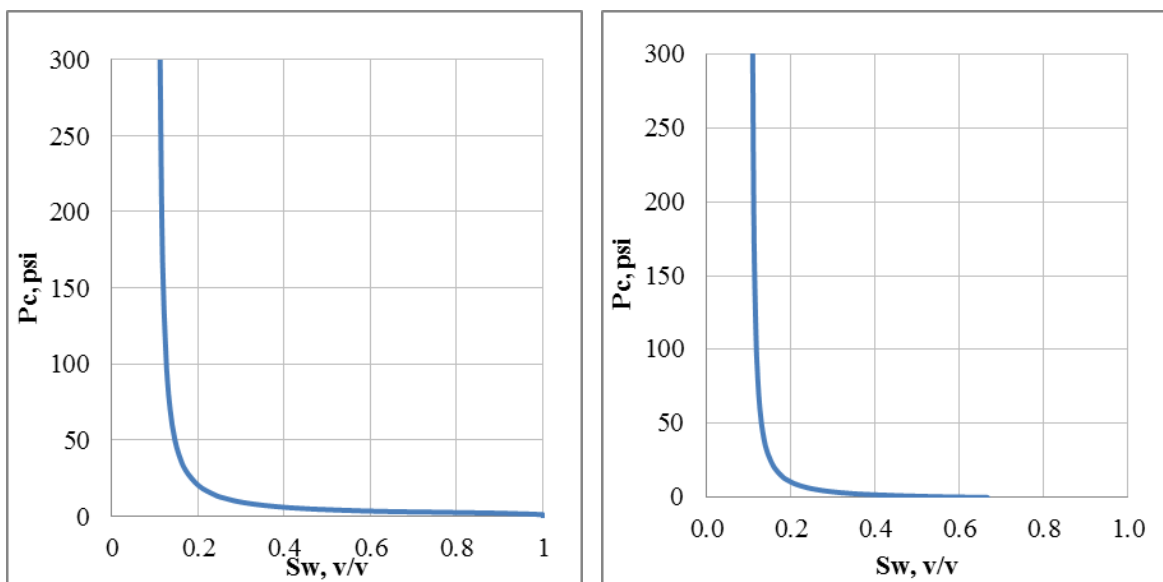

**Figure 20.** Capillary pressure curves for drainage (left) and imbibition (right).

### Simulation results

Figure 21 shows the maximum lateral migration of the CO<sub>2</sub> plume approximately 25 and 15 years after cessation of CO<sub>2</sub> injection activities at John Creek and Davis Ranch sites respectively. The plume grows rapidly during the injection phase and is largely stabilized by the end of injection period. CO<sub>2</sub> travels throughout the reservoir for additional several years and enters stabilization phase after several years post injection commencement.

Figure 22 presents the distribution of reservoir pore-pressure at the maximum point of CO<sub>2</sub> injection. The pressure increases are estimated to be below 750 psi on commencement of injection and then pressure

gradually drops after the commencement of the injection as the capillary effects are overcome. The pressure decreases to almost pre-injection levels after approximately 50 years.

Figure 23 and 24 illustrate modeled maximum injection rates and cumulative injection volumes obtained via injection by 3 injection wells completed at Simpson and Arbuckle intervals. Maximum combined for 3 wells injection rate modeled for Davis Ranch Field was 940 metric tonnes/day. Maximum combined for 3 wells injection rate modeled for John Creek was significantly higher at 3,000 metric tonnes/day. Overall, John Creek Field proved to be better suited for accommodating commercial CO<sub>2</sub> storage project. Although cumulative CO<sub>2</sub> injection was projected at 21MMT it is possible to improve this projection via altering injection strategies and by expanding modeled areal extent.



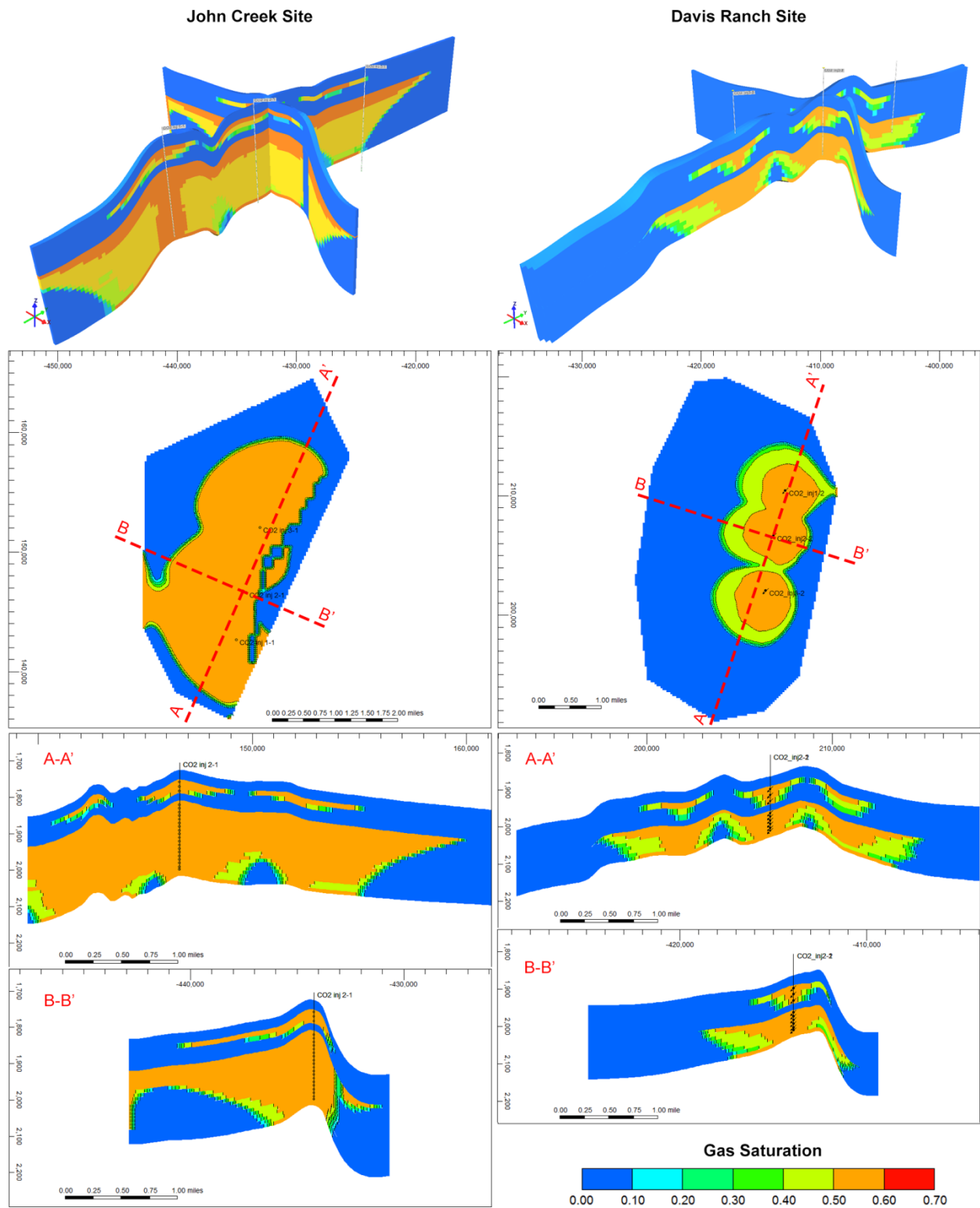
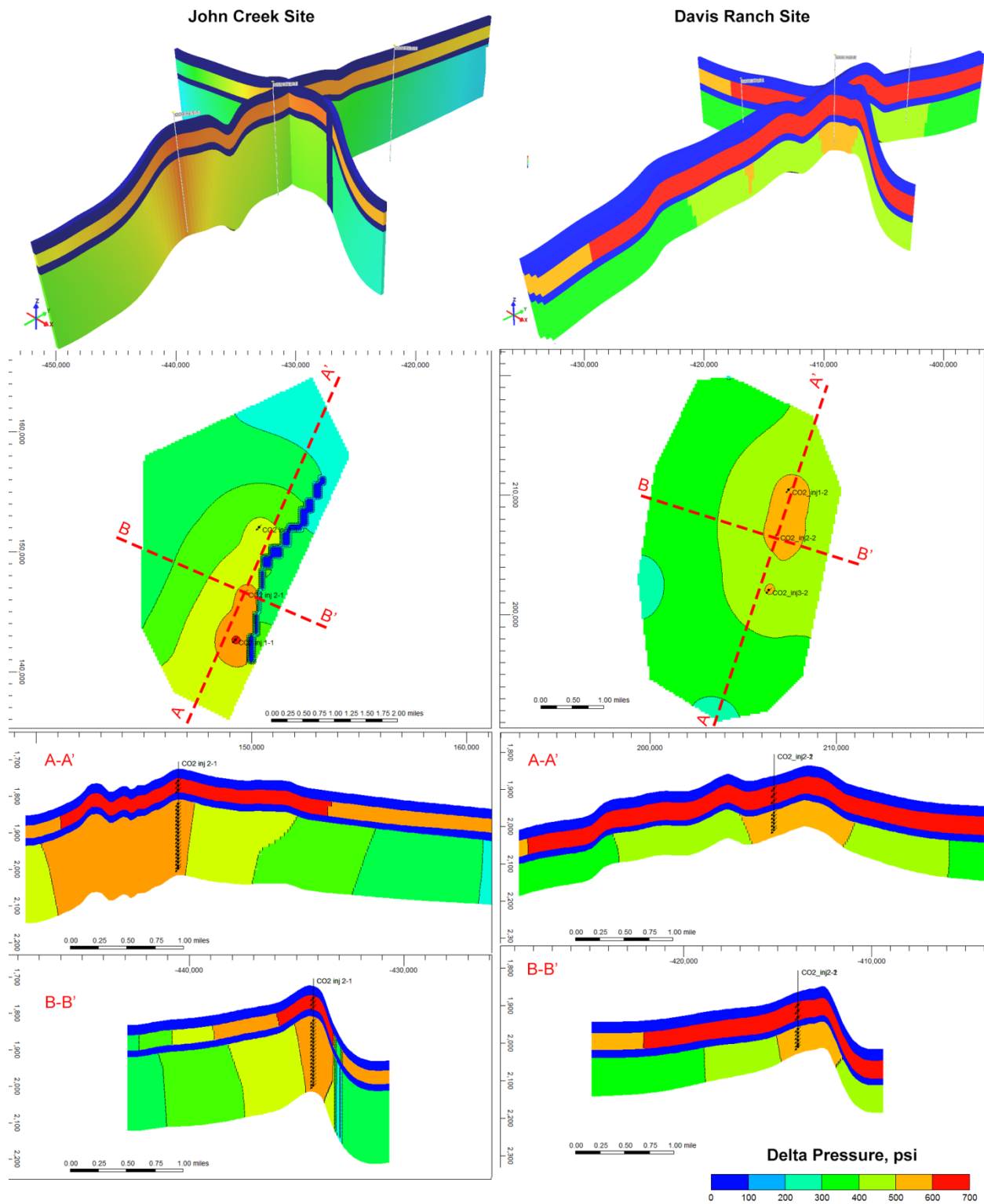
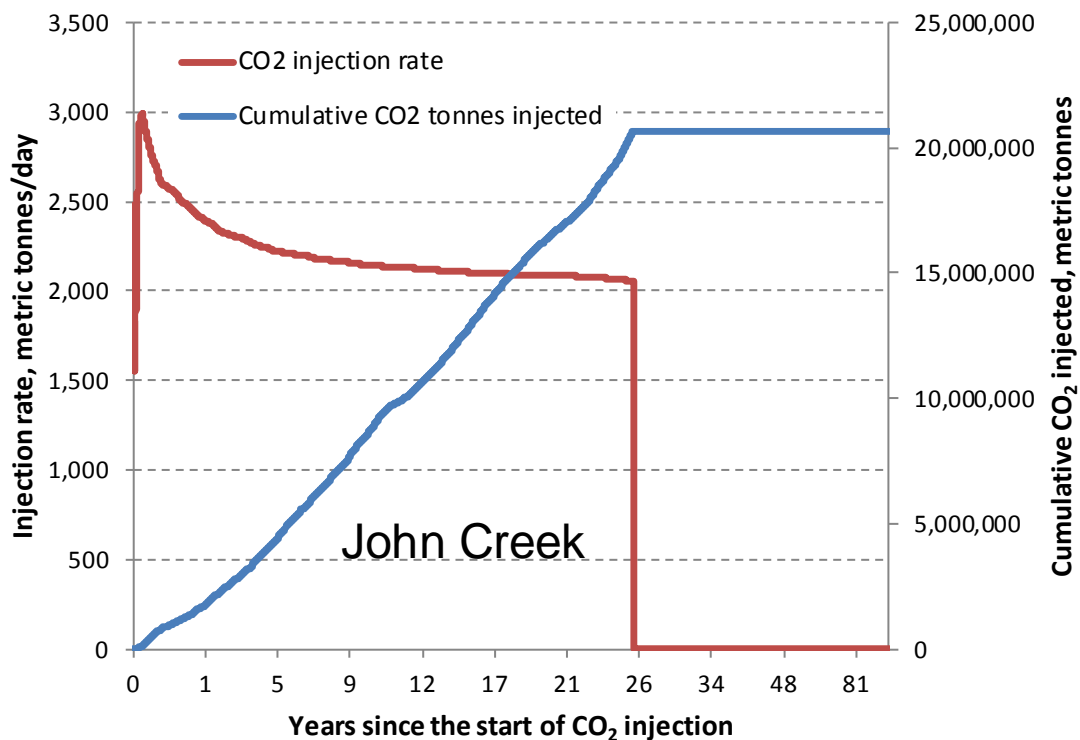
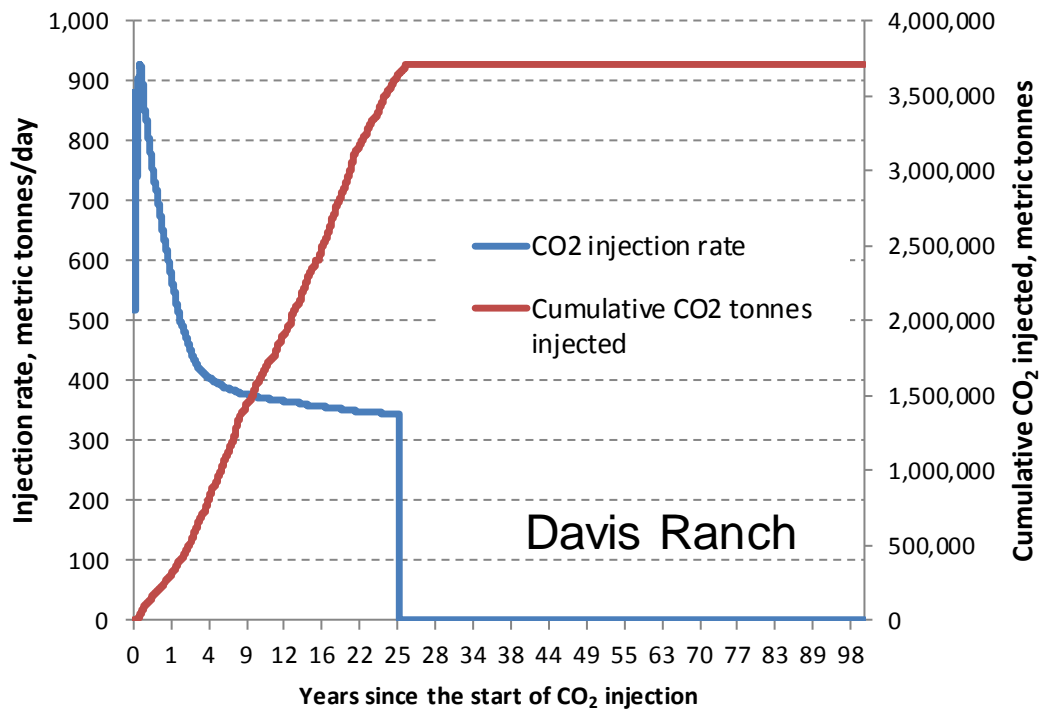

Figure 21. Maximum CO<sub>2</sub> plume distribution at John Creek (left) and Davis Ranch (right) sites



**Figure 22.** Maximum reservoir pressure increases because of CO<sub>2</sub> injection at John Creek (left) and Davis Ranch (right) sites



**Figure 23.** Cumulative CO<sub>2</sub> injected and CO<sub>2</sub> injection rate for Davis Ranch and John Creek sites. In both cases, the plots account for 3 wells completed at two intervals: Simpson and Arbuckle.

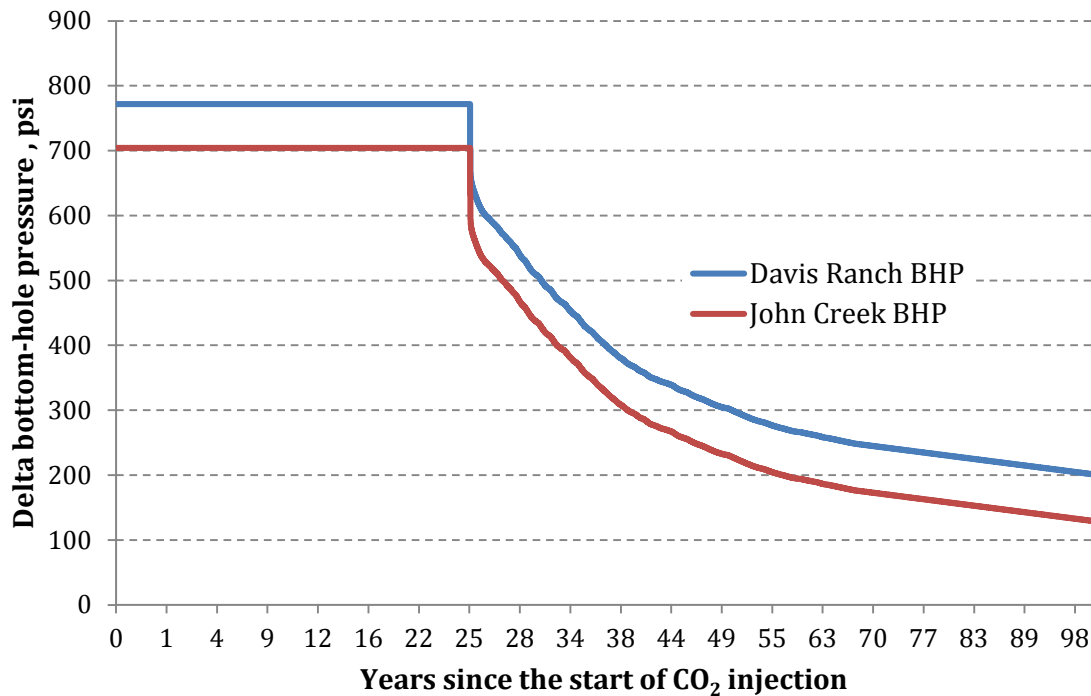

**Figure 24.** Bottom-hole pressure profiles for CO<sub>2</sub> injection

## GEOCHEMISTRY

Geochemical analysis was deployed to verify the potential for seals above the target injection zones in the study area. The Forest City Basin is an oil producing region with traps contained by structures and vertical seals. Oil production in the two study fields is from the Kansas City Group, well above the Simpson, and the Viola, in close proximity above the Simpson (Figure 2). Although the Simpson Sandstone does not produce in either field, it does carry oil shows in the samples and is productive in nearby fields, indicating a vertical seal. The Arbuckle does not produce oil in the Forest City Basin.

Comparison of salinities in the reservoirs at John Creek and Davis Ranch Fields (Fig. 25) has utility for inferring the potential for cross-stratigraphic flow, or *leakage*, between reservoirs. Gradually increasing salinity with depth regardless of apparently separate reservoir may indicate communication between reservoirs. Conversely, contrasts in the salinity of the waters in the principal reservoirs of the Davis Ranch Field and the nearby John Creek Field may indicate that the reservoirs are isolated from each other. Such salinity contrasts thus may assure that each reservoir will not leak when they are separately charged with CO<sub>2</sub>. Salinity data was therefore examined for the Hunton, Viola, Simpson, and Arbuckle reservoirs.

### Data availability and methodology

There are four basic sources of information on salinity: the Kansas Geological Survey on-line brine database, chemical analyses of produced water donated by oilfield operators, salinity analyses reported for water recovered in drill-stem tests, and salinity determined from geophysical well logs.

Very few analyses of produced water are available from the KGS on-line brine database. Similarly, drill-

stem tests (DSTs) recovering sufficient amounts of water are not numerous near the Davis Ranch and John Creek fields. Most chemical analyses donated by oil-field operators are limited to the producing intervals from each oil field (i.e., Hunton and Viola at Davis Ranch; Viola at John Creek). The well-log resistivity method thus had to be employed to generate most of the salinity data.

The well-log resistivity method utilizes a rearrangement of the Archie Equation to determine the resistivity of formation water ( $R_w$ ).  $R_w$  is then converted to a salinity measurement (Doveton, 2004). Input into the formula includes a porosity and resistivity measurements, usually averaged over a two-foot vertical interval. The porosity used is an average of the neutron and density porosity measurements. The resistivity measurement is that of the deep induction log, to measure resistivity away from the vicinity of the well bore, which is subject to the effects of drilling mud and mud filtrate. Reservoir intervals with  $>50$  API gamma ray units were not used in the analysis (so the effects of shaliness could be avoided), nor were tight zones measured where porosity is  $<8\%$ . Oil-bearing zones were ignored, so that any resistivity measured in any given reservoir would be due principally to that of the formation water.

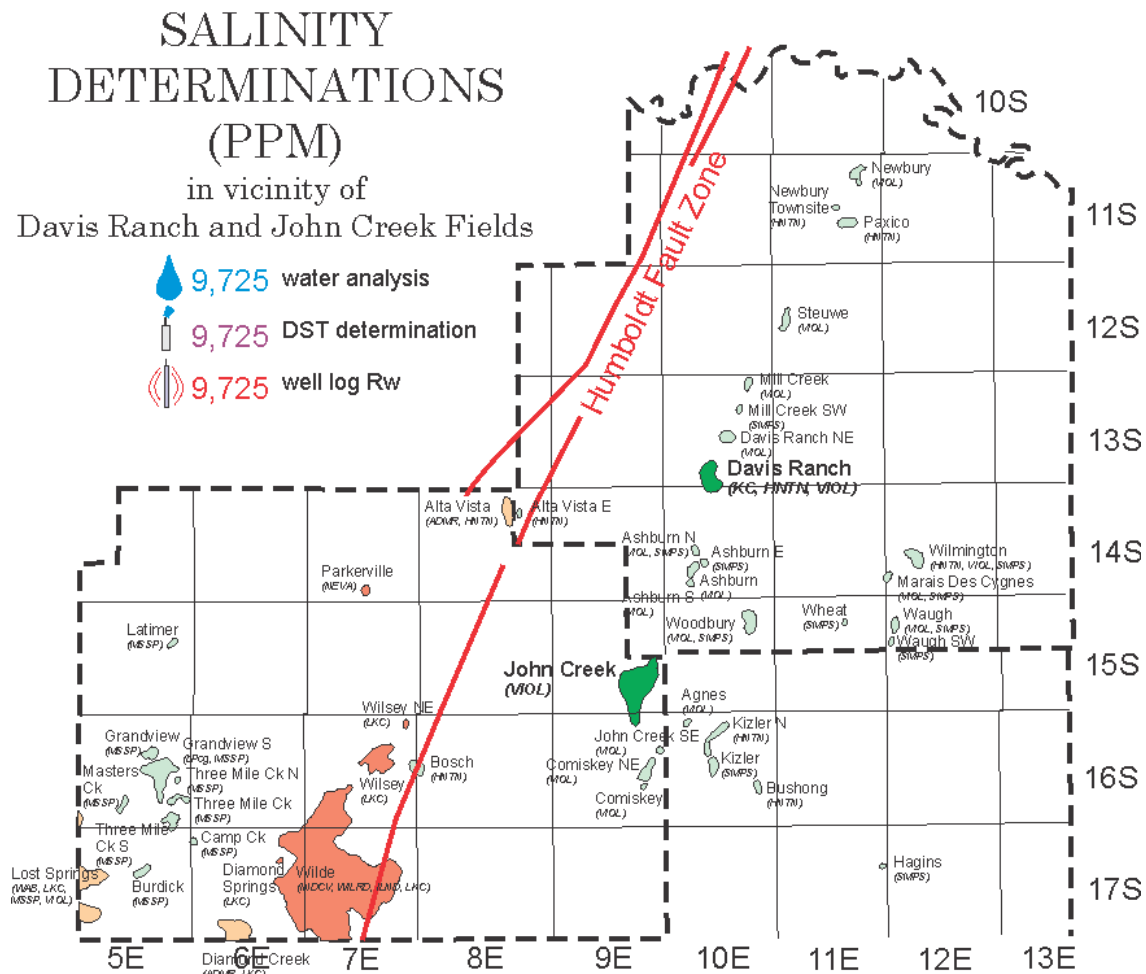

**Figure 25.** Map of a portion of the Forest City Basin, bounded by the Humboldt Fault Zone in Northeast Kansas. The two study fields are color-filled green,

**Analysis**

Approximately two dozen wells were analyzed using the well-log resistivity method in the Davis Ranch-John Creek study area. Salinity was determined in the Hunton (Fig. 26), Viola (Fig. 27), Simpson (Fig. 29) and Arbuckle (Fig. 29). If allowed by well-log coverage, as many as four reservoirs were examined in a well – Hunton, Viola, Simpson, and Arbuckle. In general, the Hunton – the shallowest of all the reservoirs examined – had the least saline water. Sandstone in the Simpson had the most saline water. Regionally, water in all four reservoirs increased in salinity eastward into the Forest City basin. Diagrams of salinity vs. subsea depth at both Davis Ranch (Fig. 30) and John Creek (Fig. 31) show increased salinity downward, from Hunton, to Viola, and then in the Simpson. From Simpson to Arbuckle, however, this trend of increasing salinity reverses, and the Arbuckle is generally less saline than the overlying Simpson. This trend of increasing salinity with depth and age of reservoir, and then lesser salinity into the Arbuckle causes a dog-leg pattern in diagrams of depth vs. salinity for individual wells (Figs. 30, 31).

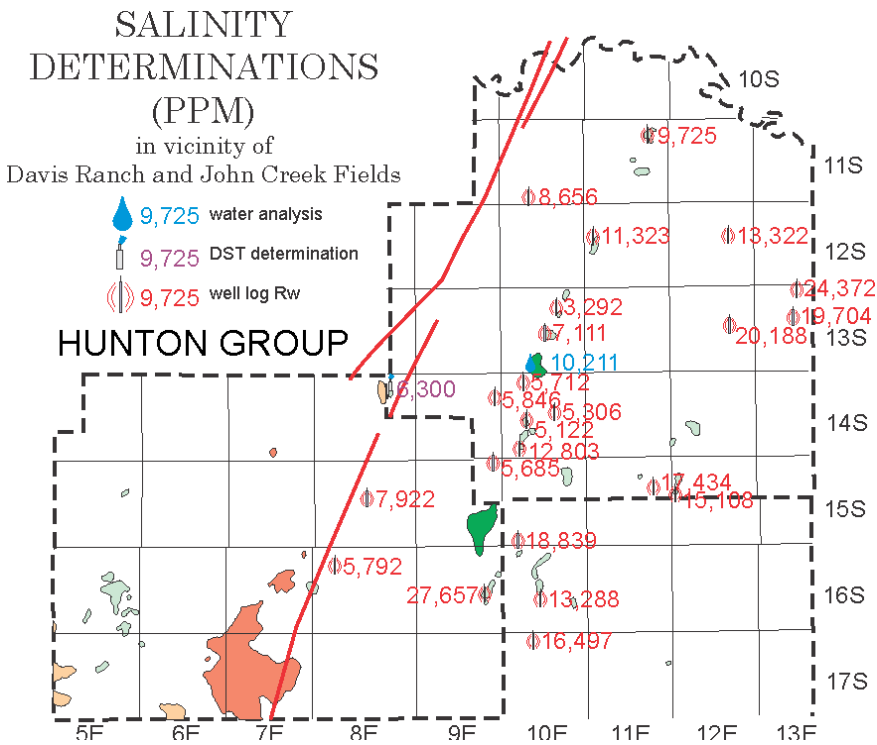

Figure 26. Salinity analysis for the Hunton Group

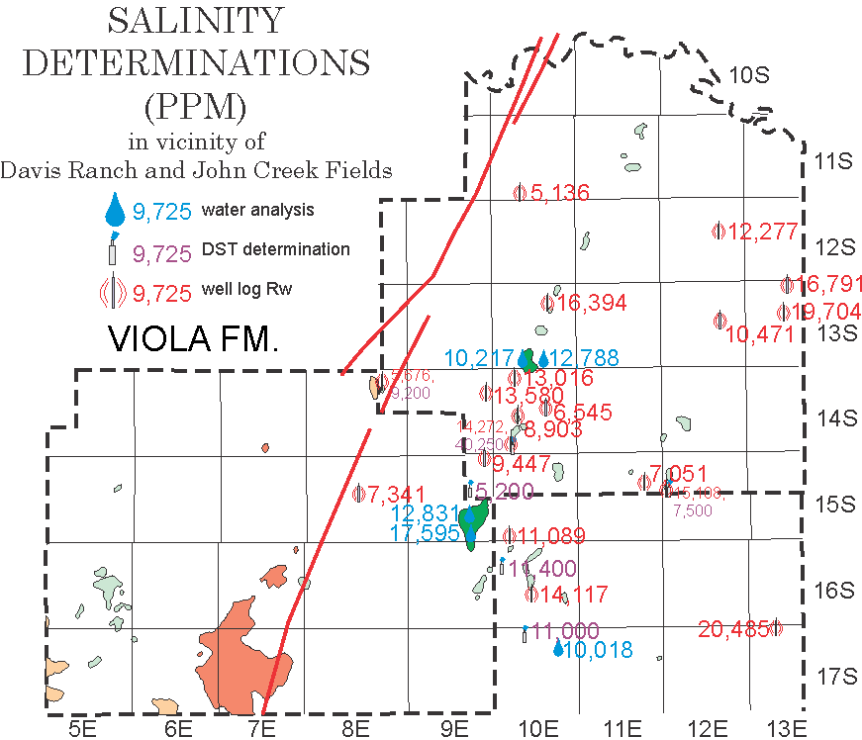

Figure 27. Salinity analysis for the Viola Formation

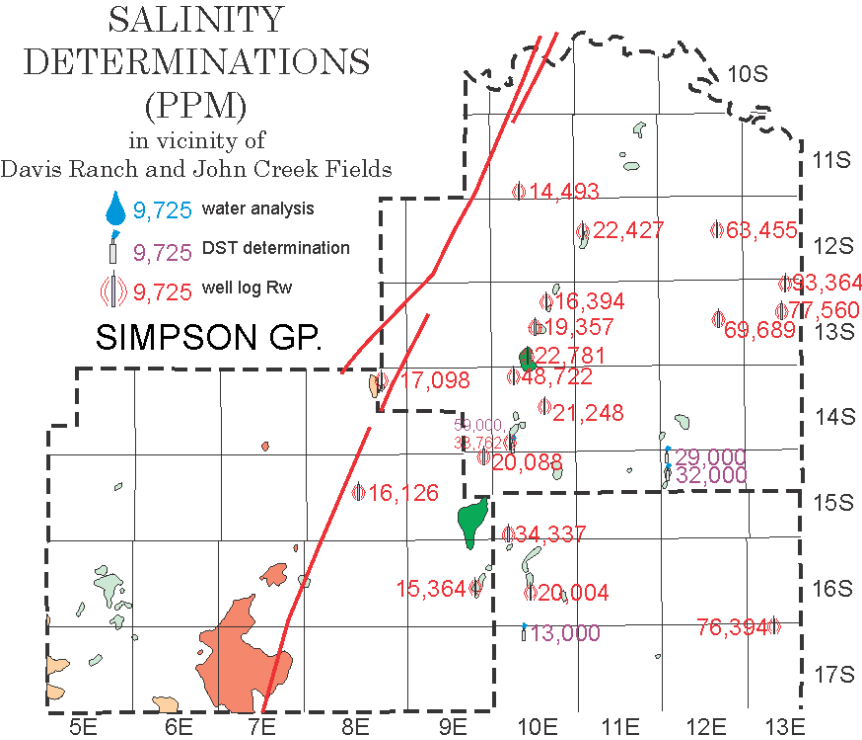

Figure 29. Salinity analysis for the Simpson Group

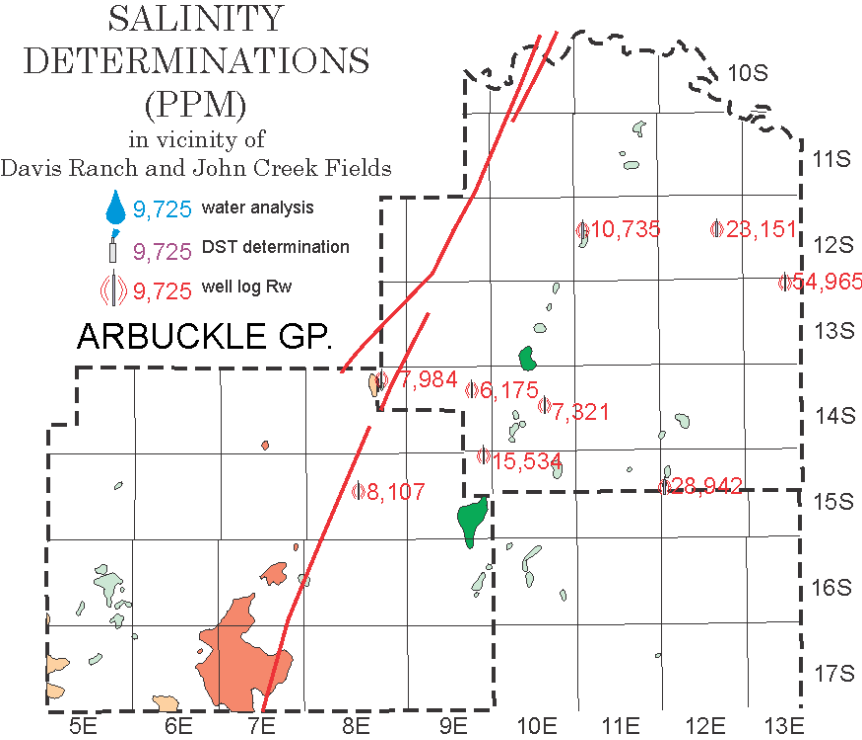

Figure 29. Salinity analysis for the Arbuckle Group

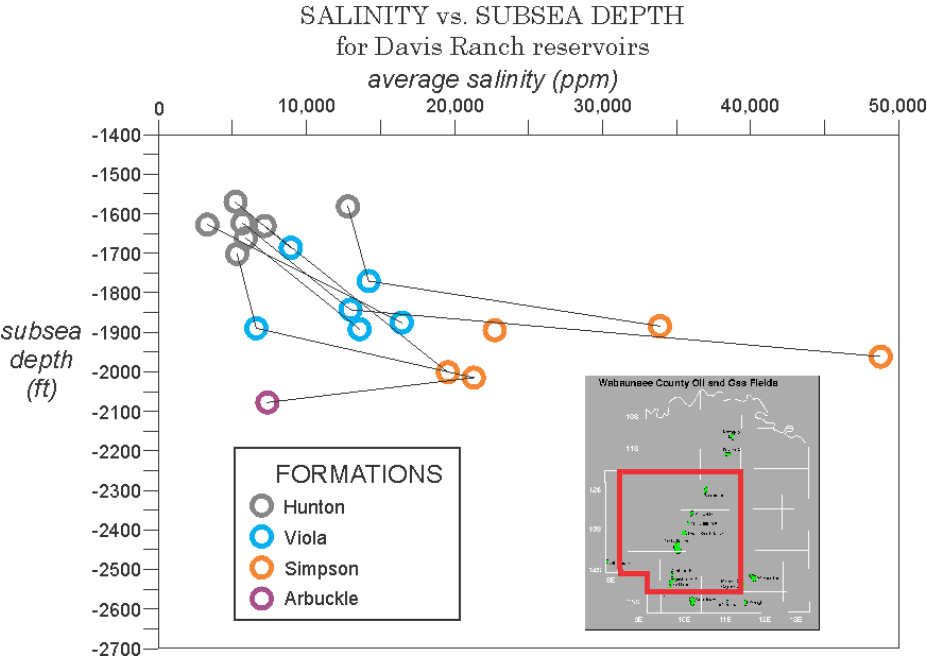
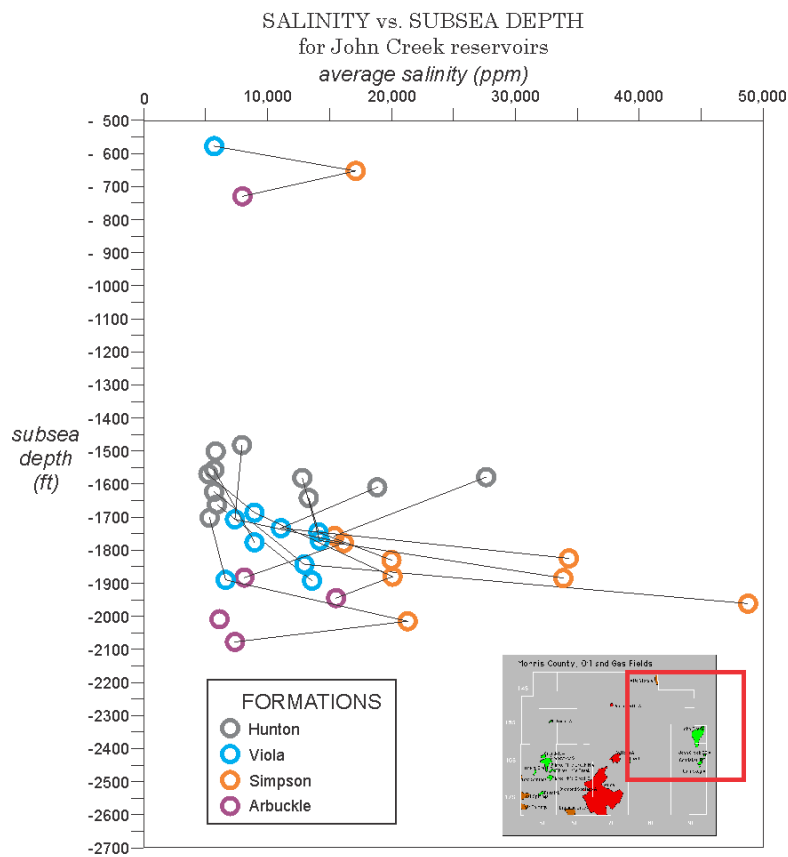

Figure 30. Salinity vs. depth plots for the Davis Ranch field. Lines connect dots from a common well.





**Figure 31.** Salinity vs. depth plots for the John Creek field. Lines connect dots from a common well.

### Discussion and Conclusions

Presumably, since several ionic species are being measured in set laboratory conditions, a chemical analysis of produced water will be the most accurate type of salinity measurement. In contrast DSTs recover several hundred feet of water in pipe may be sampling unknown amounts of both formation water and drilling fluid, although the more water recovered in a DST would likely indicate that formation water represents a greater portion of any fluid recovered. Salinity analyses of water recovered in DSTs are also problematic in that the analysis may be performed at the well site under less-than-ideal conditions. Some inconsistencies are evident between some analyses and localities. For example, a Simpson DST in sec. 32-T.14S-R.10E. differs by over 20,000 ppm from a well-log derived salinity in the same well (Fig 29). In this case the DST measurement is somewhat suspect, as it is more than all other measurements nearby. Some salinities also evidently change in short distances, for example, two chemical analyses from the Viola at the John Creek from samples taken less than two miles from each other, registered 12,831 and 17,595 ppm (Fig. 27).

Thick shale units, more than 50 ft thick, isolate the Hunton from other reservoirs (Figure 2). The Devonian-Mississippian Chattanooga Shale overlies the Hunton. The Upper Ordovician Maquoketa Shale underlies the Hunton, and separates the Hunton from the underlying Viola reservoir. The abruptly greater salinity of the Viola compared to the Hunton, and the presence of thick shales enveloping the Hunton indicates that the Hunton is isolated from the Viola, Simpson, and Arbuckle reservoirs.

Thin (10 to 20 ft thick) shales and non-porous limestone, 40 to 70 ft thick, separate the Simpson from the overlying Viola reservoir, whereas only thin shales separate the Simpson from the Arbuckle. The drastically higher salinity in the Simpson compared to the Arbuckle at both Davis ranch and John Creek, however, strongly indicates that the Simpson is isolated from both the Viola above and the Arbuckle below. We thus conclude that there will be no natural leakage of sequestered CO<sub>2</sub> out of the four separate reservoirs at Davis Ranch and John Creek. None of the four reservoirs appears to be communicated with any of the other reservoirs.

## References:

Bui, L. H., Tsau, J. S., and Willhite, G. P., 2010, Laboratory investigations of CO<sub>2</sub> near-miscible application in Arbuckle Reservoir: SPE Improved Oil Recovery Symposium held in Tulsa, Oklahoma, 24–28 April 2010, SPE Publication 129710.

Carter, R. D., and Tracy, G. W., 1960, An improved method for calculating water influx: Petroleum Transactions, AIME, vol. 219, p. 415–417.

Chang, K. W., Minkoff, S. E., and Bryant, S. L., 2009, Simplified model for CO<sub>2</sub> leakage and its attenuation due to geological structures: Energy Procedia, v. 1, p. 3,453–3460.

Dake, L. P., 1978, Fundamentals of Reservoir Engineering," Chapter 9, Elsevier Scientific Publishing Co., 1978.

Doveton, J.H., 2004, Applications of estimated formation water resistivities to brine stratigraphy in the Kansas subsurface: Kansas Geological Survey, Open-File report 2004-22, 20 p.

Fazelalavi, M., Determination of Relative Permeability Curves in the Arbuckle, KGS Open File Report 2017-6, July 22, 2015

Kansas Geological Survey, 2003, MidCarb CO<sub>2</sub> online property calculator, [http://www.kgs.ku.edu/Magellan/Midcarb/co2\\_prop.html](http://www.kgs.ku.edu/Magellan/Midcarb/co2_prop.html). Accessed on July 12, 2017.

Kestin, J., Khalifa, H. E., and Correia, R. J., 1981, Tables of the dynamic and kinematic viscosity of aqueous NaCl solutions in the temperature range 20–150 °C and the pressure range 0.1–35 MPa: Journal of Physical and Chemical Reference Data, NIST, v. 10, p. 71–88.

Li, Y. K., and Nghiem, L. X., 1986, Phase equilibrium of oil, gas and water/brine mixtures from a cubic equation of state and Henry's Law: Canadian Journal of Chemical Engineering, June, p. 486–496.

Sørenseide, I., and Whitson, C. H., 1992, Peng-Robinson predictions for hydrocarbons, CO<sub>2</sub>, N<sub>2</sub>, and H<sub>2</sub>S with pure water and NaCl brine: Fluid Phase Equilibria, v. 77, p. 217–240.

Watney, W.L. et al., 2015, Modeling CO<sub>2</sub> Sequestration in Saline Aquifer and Depleted Oil Reservoir to Evaluate Regional CO<sub>2</sub> Sequestration Potential of Ozark Plateau Aquifer System, South-Central Kansas, Final Report, Award Number: DE-FE0002056, submitted October 2, 2015, 4867 p.

Watney, W.L., 2016, Integrated CCS for Kansas (ICKan) SF 424 R&R, Application for Federal Assistance, Phase I - Integrated CCS Pre-Feasibility Study activity under CarbonSAFE, DOE-NETL FOA 1584.

## Appendix C

### Appendix C: Modifications to FE/NETL CO<sub>2</sub> Transport Cost Model and preliminary CO<sub>2</sub> pipeline cost estimates

Martin K. Dubois<sup>1</sup> and Dane McFarlane<sup>2</sup>

1 – Improved Hydrocarbon Recovery, LLC, 2 – Great Plains Institute

#### Overview

Understanding the economics of and exploring options and strategies to transport CO<sub>2</sub> from large-scale anthropogenic sources, particularly coal-fired power plants, in the most optimal manner is a key component of the Integrated CCS for Kansas project (ICKan). Estimating cost for variety of pipeline scenarios is the first step in the process. Because large-scale coal-fired power plants (e.g.: Jeffrey Energy Center) are distant to potential storage sites, pipelines are the only option for transporting large volumes of CO<sub>2</sub>. However, pipelines have extremely high capital costs that negatively impact the overall costs and feasibility for CCS projects. The ICKan project considers the option of reducing the net costs for CO<sub>2</sub> transported for CCS by combining CO<sub>2</sub> captured from power plants and/or a refinery with CO<sub>2</sub> destined for EOR operations. One case would include a very large-scale system where CO<sub>2</sub> is captured from 32 ethanol plants in the Upper Midwest and joined with CO<sub>2</sub> captured from a power plant (Westar's Jeffrey Energy Center). CO<sub>2</sub> would then be transported to a saline aquifer storage site as well as to EOR markets. Both sides would benefit by the economies of scale for the pipeline system. Another case considered (without the ethanol CO<sub>2</sub> component) is for the capture be scaled large enough to sell CO<sub>2</sub> for EOR, again gaining the benefits from scale and possible from revenues generated by the sale of CO<sub>2</sub> for EOR. In this high-level study we used a modified Transport Cost Model developed by the National Energy Technology Laboratory (NETL) to estimate costs (Grant, et al., 2013; Grant and Morgan, 2014). In the very large-scale scenario described above, the modeled pipeline system could transport 13.4 million tonnes of CO<sub>2</sub>/year at an approximate cost of \$16/tonne, excluding interest and business margin.

#### FE/NETL CO<sub>2</sub> Transport Cost Model and modifications

The Great Plains Institute (GPI) and Improved Hydrocarbon Recovery, LLC (IHR), collaborators on the ICKan project, identified the National Energy Technology Laboratory's (NETL) CO<sub>2</sub> Transport Cost Model as a resource for estimating the technical requirements and costs of CO<sub>2</sub> transport through pipelines. The NETL model takes a wide variety of inputs including pipeline route length, CO<sub>2</sub> capacity, pressure, project financing, and other areas, and calculates multiple components of capital and operating and maintenance costs, as well as technical specifications such as minimum pipeline diameter. Calculations are done through both spreadsheet formulas and more complex Excel Visual Basic for Applications (Excel VBA) functions.

The ICKan project requires the assessment of pipeline networks comprised of multiple trunk segments and many feeder lines connected to individual CO<sub>2</sub> sources, however, the original NETL model calculates specifications and costs for only one pipeline at a time. To streamline the process of calculating many pipeline network segment costs, GPI created additional Excel VBA macro functionality to interact with the NETL cost model. Without changing or modifying the NETL spreadsheets or VBA code in anyway, GPI created a VBA macro that collects inputs from a list of pipeline segments, inputs the parameters for each segment, and records the model outputs for each segment individually. The inputs and outputs are summarized in Table 1. Model costs are in 2011 dollars, the model default.

<b>Inputs (by segment)</b>	<b>Outputs (by segment)</b>
length (miles)	minimum pipeline ID (inches)
number of booster pumps	pipeline nominal diameter (inches)
annual CO2 transport capacity (MT/yr)	materials costs
capacity factor	labor costs
input pressure (psig)	ROW-damage costs
output pressure (psig)	miscellaneous costs
change in elevation (feet)	CO2 surge tanks costs
	pipeline control system costs
	pump costs
	<b>Total capital cost</b>
	pipeline O&M
	other equipment and pumps O&M
	electricity costs for pumps
	<b>Total annual operating expenses</b>

**Table 1:** Model inputs and outputs. Abbreviations include: MT/yr – million tonnes/year, psig – pounds per square inch gauge, ID – inside diameter, ROW – right of way, O&M – operations and maintenance.

### CO2 Sources: Midwestern ethanol and Kansas energy facilities

Ethanol plants from the upper Midwest and energy facilities in Kansas are the CO2 sources in this study. Four Kansas energy facilities are industry partners in the ICKan project: Westar Jeffrey Energy Center, Kansas City Board of Public Utilities’ Dearman Creek, CHS McPherson refinery, and the Sunflower Holcomb Station power plant. All except CHS are coal-fired power plants. CO2 emitted annually and the estimated volume that could reasonably be available from each facility is provided in Table 2.

	<b>Mwe</b>	<b>Approx. CO2 Emitted (MT/yr)</b>	<b>Est. Vol. Available (MT/yr)</b>
Jeffrey Energy Center	2400	12.5	2.5
Dearman Creek	261	1.2	?
Holcomb Station	350	1.8	?
CHS refinery	NA	1.4	0.76

**Table 2.** Industry partner CO2 source data. Abbreviations include Mwe – megawatt electric and MT/yr – million tonnes/year.

The location and production capacity of US ethanol plants is sourced from the US Department of Energy (U.S. DOE, 2017). Thirty-two ethanol plants within the region that could supply CO2 to a modeled pipeline network are shown in Table 3. These plants represent a total of approximately 3.6 billion gallons of ethanol production per year and 10.9 million metric tons of CO2. The volume of CO2 was calculated at a rate of 6.624 lbs. CO2/gallon ethanol (Dubois et al., 2002).

Company	Ethanol Plant	State	Ethanol Capacity (MGPY)	CO2 output (Tonne/year)
ABSOLUTE ENERGY LLC	ST ANSGAR	IA	110	330,449
ADM CEDAR RAPIDS IA DRY MILL	CEDAR RAPIDS DRY MILL	IA	300	901,224
ADM CLINTON IA	CLINTON	IA	237	711,967
BIG RIVER UNITED ENERGY LLC	DYERSVILLE	IA	100	300,408
CARGILL INC	FORT DODGE	IA	113	339,461
FLINT HILLS RESOURCES FAIRBANK LLC	FAIRBANK	IA	100	300,408
FLINT HILLS RESOURCES LLC	ARTHUR	IA	100	300,408
FLINT HILLS RESRCS MENLO LLC	MENLO	IA	100	300,408
FLINT HILLS RESRCS SHELL ROCK	SHELL ROCK	IA	100	300,408
FRONTIER ETHANOL LLC	GOWRIE	IA	60	180,244
GOLDEN GRAIN ENERGY LLC	MASON CITY	IA	107	321,436
HOMELAND ENERGY SOLUTIONS LLC	LAWLER	IA	100	300,408
LITTLE SIOUX CORN PROCESSORS LP	MARCUS	IA	92	276,375
LOUIS DREYFUS COMMODITIES	GRAND JUNCTION	IA	100	300,408
PENFORD PRODUCTS CO	CEDAR RAPIDS	IA	45	135,183
VALERO RENEWABLE FUELS LLC	ALBERT CITY	IA	110	330,449
VALERO RENEWABLE FUELS LLC	CHARLES CITY	IA	110	330,449
VALERO RENEWABLE FUELS LLC	FORT DODGE	IA	110	330,449
VALERO RENEWABLE FUELS LLC	HARTLEY	IA	110	330,449
PRAIRIE HORIZON AGRI-ENERGY LLC	PHILLIPSBURG	KS	40	120,163
US ENERGY PARTNERS	RUSSELL	KS	55	165,224
ABENGOA BIOENERGY OF NEBRASKA LLC	RAVENNA	NE	88	264,359
ADM COLUMBUS NE DRY MILL	COLUMBUS DRY MILL	NE	313	940,277
ADM COLUMBUS NE WET MILL	COLUMBUS WET MILL	NE	100	300,408
AVENTINE - AURORA WEST LLC	AURORA WEST	NE	108	324,440
CARGILL INC	BLAIR	NE	210	630,857
CHIEF ETHANOL FUELS INC	HASTINGS	NE	70	210,285
FLINT HILLS RESOURCES	FAIRMONT	NE	100	300,408
GREEN PLAINS CENTRAL CITY LLC	CENTRAL CITY	NE	100	300,408
GREEN PLAINS WOOD RIVER LLC	WOOD RIVER	NE	110	330,449
NEBRASKA ENERGY LLC	AURORA	NE	45	135,183
VALERO RENEWABLE FUELS LLC	ALBION	NE	100	300,408

**Table 3.** Thirty-two ethanol plants considered in a large-scale CO<sub>2</sub> gathering system. The abbreviation MGPY is million gallons per year.

### Cost projections for four cases

In an initial analysis, equipment requirements and estimated capital and operating costs for four separate pipeline scenarios were determined using the modified Transport Cost Model. In the largest scenario a pipeline network was designed to gather CO<sub>2</sub> from 32 ethanol plants and Jeffrey Energy Center, Kansas' largest CO<sub>2</sub> source, and transport the CO<sub>2</sub> through Kansas to a saline aquifer storage site (Pleasant Prairie). From there it would continue to the Permian Basin, an area with an active enhanced oil recovery (EOR) industry (Figure 1). ESRI ArcGIS geographic information system mapping program and the North American Datum 1983 (2011 national adjustment) geographic projection, were utilized to build the system

and estimate the length of straight-line pipeline segments. Because actual pipeline siting is not a straight line, involving rights-of-way deliberations and physical obstacles, each segment was multiplied by a factor of 1.2 to approximate additional routing requirements.

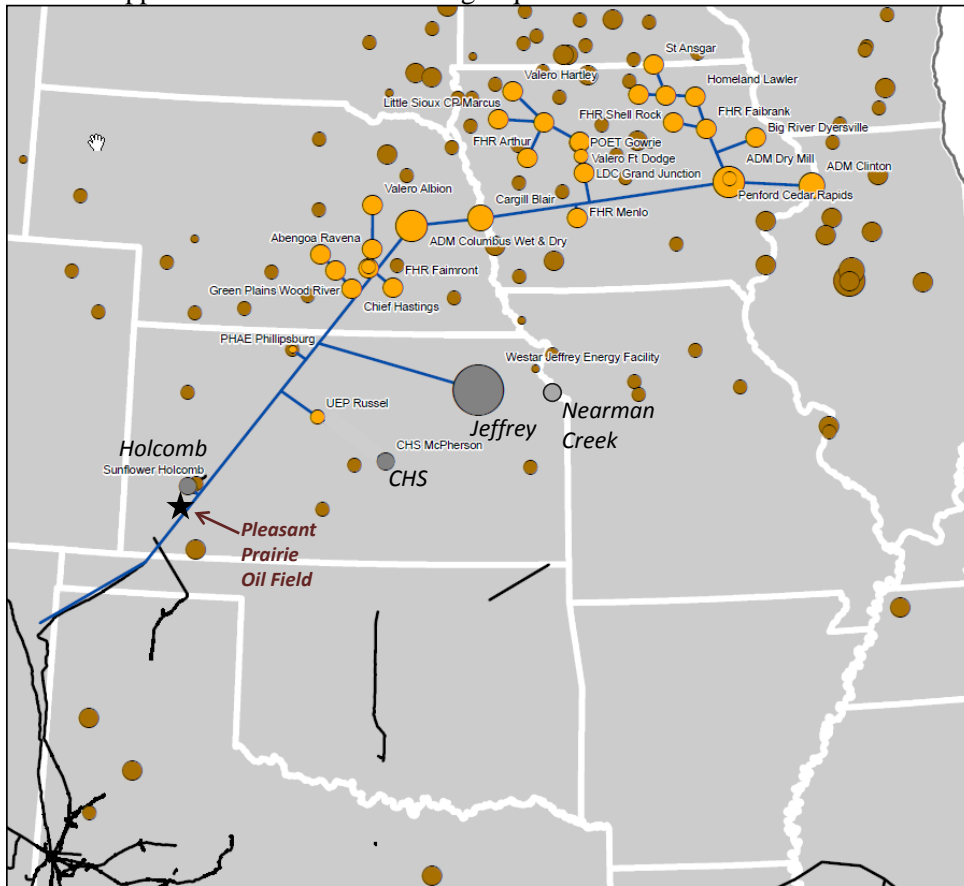

**Figure 1.** Pipeline Scenario 1, connecting 32 ethanol plants and delivering CO<sub>2</sub> to Kansas, Oklahoma and Texas. Bubbles are sized according to CO<sub>2</sub> volume. Ethanol plants are yellow (in the evaluated scenario) and brown (not in the scenario). Gray circles are ICKan industry partners, one of which is shown to be connected under this scenario. Pleasant Prairie is one of the storage sites considered in the project. Black line segments are existing CO<sub>2</sub> pipeline infrastructure.

Table 4 is an input/output table that represents the modified portion of the Model for the large-scale project described above. Inputs are provided by the user and the balance of the table is calculated output based on the input data. The cost model assumes that CO<sub>2</sub> is delivered into the pipeline system at a set pressure, 2200 psig this case. For this analysis, the pressure was allowed to drop to 1600 psig before it was pumped back to 2200 psig by booster pumping stations along the route. A minimum of one pump per segment is required by the model. Costs are most sensitive to pipeline diameter and the diameter required is a function of pressure and volume to be transported. Because booster pump stations in this model are relatively inexpensive in comparison to the pipeline, one can optimize for cost by varying the number of pump stations to reduce pipeline diameter, as was done in this analysis. The number of pump stations ranges from one to fifteen and pipe diameter is from four to 24 inches in diameter.

Inputs								Pipeline Diameter		Capital Cost								Annual O&M Cost				
Segment ID #	Length (X1.2) mi	# of Pumps #	Annual CO2 MT/yr	Capacity factor dec.	Input Pressure psig	Outlet Pressure psig	Change in Elev. ft	Minimum Pipeline Inner Diameter in	Pipeline Nominal Diameter in	Materials \$K	Labor \$K	ROW-Damages \$K	Miscellaneous \$K	CO2 Surge Tanks \$K	Pipeline Control system \$K	Pumps \$K	Total Capital \$K	Pipeline O&M \$K	Pipeline related equipment pumps \$K	Electricity costs for pumps \$K	Total annual operating expenses \$K	
20	44.6	2	1.24	0.8	2200	1600	0	6.97	8.00	\$4,880	\$19,083	\$2,020	\$5,346	\$1,245	\$112	\$931	\$33,617	\$378	\$92	\$413	\$883	
13	47.8	2	0.30	0.8	2200	1600	0	4.11	6.00	\$4,199	\$19,083	\$2,088	\$4,458	\$1,245	\$112	\$353	\$31,538	\$405	\$68	\$100	\$573	
16	43.0	2	0.30	0.8	2200	1600	0	4.03	6.00	\$3,786	\$17,215	\$1,885	\$4,028	\$1,245	\$112	\$353	\$28,623	\$364	\$68	\$100	\$533	
26	0.7	1	0.14	0.8	2200	1600	0	1.47	4.00	\$122	\$644	\$82	\$195	\$1,245	\$112	\$125	\$2,525	\$6	\$59	\$23	\$88	
11	8.6	1	1.06	0.8	2200	1600	0	5.17	6.00	\$812	\$3,732	\$417	\$922	\$1,245	\$112	\$411	\$7,650	\$73	\$71	\$177	\$320	
27	3.5	1	0.14	0.8	2200	1600	0	1.98	4.00	\$318	\$1,670	\$196	\$373	\$1,245	\$112	\$125	\$4,038	\$30	\$59	\$23	\$112	
12	21.5	1	0.60	0.8	2200	1600	0	4.96	6.00	\$1,926	\$8,781	\$967	\$2,085	\$1,245	\$112	\$269	\$15,384	\$182	\$65	\$100	\$347	
23	31.9	2	0.98	0.8	2200	1600	0	5.98	6.00	\$2,827	\$12,868	\$1,412	\$3,027	\$1,245	\$112	\$773	\$22,264	\$270	\$85	\$328	\$683	
30	46.1	2	0.30	0.8	2200	1600	0	4.08	6.00	\$4,056	\$18,434	\$2,018	\$4,309	\$1,245	\$112	\$353	\$30,526	\$391	\$68	\$100	\$559	
29	63.0	2	2.18	0.8	2200	1600	0	9.27	12.00	\$10,564	\$31,333	\$3,019	\$10,802	\$1,245	\$112	\$1,515	\$58,589	\$534	\$115	\$729	\$1,378	
3	25.6	1	0.30	0.8	2200	1600	0	3.94	4.00	\$1,872	\$9,832	\$1,105	\$1,786	\$1,245	\$112	\$176	\$16,127	\$217	\$61	\$50	\$328	
31	0.6	1	0.34	0.8	2200	1600	0	1.98	4.00	\$110	\$680	\$75	\$184	\$1,245	\$112	\$188	\$2,494	\$5	\$62	\$57	\$123	
15	15.5	1	1.91	0.8	2200	1600	0	7.26	8.00	\$1,747	\$6,895	\$738	\$1,960	\$1,245	\$112	\$672	\$13,368	\$132	\$81	\$318	\$531	
14	18.7	1	2.09	0.8	2200	1600	0	7.79	8.00	\$2,084	\$8,206	\$876	\$2,324	\$1,245	\$112	\$728	\$15,574	\$158	\$83	\$348	\$590	
5	32.6	2	2.39	0.8	2200	1600	0	8.44	12.00	\$5,507	\$16,413	\$1,589	\$5,668	\$1,245	\$112	\$1,641	\$32,175	\$277	\$120	\$797	\$1,194	
7	48.0	2	0.33	0.8	2200	1600	0	4.27	6.00	\$4,217	\$19,166	\$2,097	\$4,477	\$1,245	\$112	\$371	\$31,686	\$407	\$69	\$110	\$586	
8	8.8	1	0.81	0.8	2200	1600	0	4.67	6.00	\$830	\$3,816	\$426	\$942	\$1,245	\$112	\$332	\$7,703	\$75	\$68	\$134	\$276	
22	37.1	2	1.25	0.8	2200	1600	0	6.76	8.00	\$4,069	\$15,928	\$1,688	\$4,469	\$1,245	\$112	\$940	\$28,451	\$314	\$92	\$418	\$824	
6	49.8	2	0.28	0.8	2200	1600	0	4.01	6.00	\$4,372	\$19,868	\$2,174	\$4,639	\$1,245	\$112	\$338	\$32,747	\$422	\$68	\$92	\$582	
24	29.5	1	0.32	0.8	2200	1600	0	4.15	6.00	\$2,618	\$11,919	\$1,308	\$2,808	\$1,245	\$112	\$183	\$20,193	\$250	\$62	\$54	\$365	
4	14.7	1	0.30	0.8	2200	1600	0	3.54	4.00	\$1,102	\$5,790	\$655	\$1,086	\$1,245	\$112	\$176	\$10,165	\$124	\$61	\$50	\$236	
1	17.9	1	0.12	0.8	2200	1600	0	2.59	4.00	\$1,333	\$7,004	\$790	\$1,296	\$1,245	\$112	\$121	\$11,900	\$152	\$59	\$20	\$231	
10	24.0	1	0.26	0.8	2200	1600	0	3.70	4.00	\$1,757	\$9,232	\$1,038	\$1,682	\$1,245	\$112	\$165	\$15,230	\$203	\$61	\$44	\$308	
2	48.9	2	0.17	0.8	2200	1600	0	3.29	4.00	\$3,510	\$18,439	\$2,064	\$3,275	\$1,245	\$112	\$269	\$28,914	\$414	\$65	\$55	\$534	
21	36.4	2	0.30	0.8	2200	1600	0	3.90	4.00	\$2,635	\$13,844	\$1,552	\$2,480	\$1,245	\$112	\$353	\$22,220	\$309	\$68	\$100	\$478	
25	35.6	2	0.33	0.8	2200	1600	0	4.03	6.00	\$3,152	\$14,340	\$1,572	\$3,366	\$1,245	\$112	\$371	\$24,157	\$302	\$69	\$110	\$482	
17	466.9	15	13.44	0.8	2200	1600	0	19.85	24.00	\$274,554	\$490,382	\$26,188	\$152,694	\$1,245	\$112	\$63,475	\$1,008,650	\$3,958	\$2,593	\$33,657	\$40,208	
18	75.4	3	7.25	0.8	2200	1600	0	14.39	16.00	\$20,893	\$49,838	\$3,825	\$16,857	\$1,245	\$112	\$6,963	\$99,734	\$639	\$333	\$3,631	\$4,603	
19	272.4	9	6.62	0.8	2200	1600	0	14.92	16.00	\$75,296	\$179,012	\$13,689	\$60,527	\$1,245	\$112	\$19,138	\$349,019	\$2,309	\$820	\$9,945	\$13,074	
28	91.0	3	0.71	0.8	2200	1600	0	6.12	8.00	\$9,878	\$38,529	\$4,066	\$10,748	\$1,245	\$112	\$910	\$65,487	\$771	\$91	\$356	\$1,218	
0	180.7	5	2.50	0.8	2200	1600	0	10.46	12.00	\$30,167	\$89,173	\$8,563	\$30,705	\$1,245	\$112	\$4,275	\$164,239	\$1,532	\$225	\$2,086	\$3,843	
9	26.6	1	0.59	0.8	2200	1600	0	5.15	6.00	\$2,370	\$10,794	\$1,186	\$2,549	\$1,245	\$112	\$267	\$18,523	\$225	\$65	\$99	\$390	
	1867									\$487,563	\$1,171,841	\$91,365	\$352,069	\$39,832	\$3,581	\$107,259	\$2,253,510	\$15,827	\$6,027	\$54,628	\$76,482	
<b>Total Length</b>																	<b>Total Capital Costs</b>			<b>Total Operating Costs</b>		

**Table 4.** Data by pipeline segment for scenario 1, connecting 32 ethanol plants and Jeffrey Energy Center in a large scale pipeline system. Abbreviations include mi – mile, MT/yr – million tonnes/year, dec – decimal, psig – pounds per square inch gauge, ft -feet, in – inch. Costs are in thousands of dollars.

The four scenarios summarized below are illustrated in Figures 1-3. Statistics and costs for all cases are tabulated in Tables 5 and 6.

1. Jeffery + Ethanol to storage and EOR market: CO<sub>2</sub> from 32 ethanol plants, most having been contacted by EBR, plus CO<sub>2</sub> from Westar's Jeffrey Energy Center transported to Pleasant Prairie saline aquifer storage site and the majority to EOR markets. Approximately 1867 miles of pipeline would gather and transport 13.44 million tonnes of CO<sub>2</sub> per year (MT/yr), 10.94 from 32 ethanol sources and 2.5 from Jeffrey.
2. Jeffery to nearby storage: 2.5 MT/yr CO<sub>2</sub> from Westar's Jeffrey Energy Center transported in 51 miles of pipeline to the Davis Ranch and John Creek oil fields for saline aquifer storage.
3. Jeffery + CHS to distant storage: 2.5 MT/yr CO<sub>2</sub> from Westar's Jeffrey Energy Center and 0.75 MT/yr CO<sub>2</sub> from CHS refinery transported in pipelines covering 353 miles to the Pleasant Prairie field for saline aquifer storage.
4. Jeffery to distant storage: 2.5 MT/yr CO<sub>2</sub> from Westar's Jeffrey Energy Center transported in 353 miles of pipeline to the Pleasant Prairie oil field for saline aquifer storage.

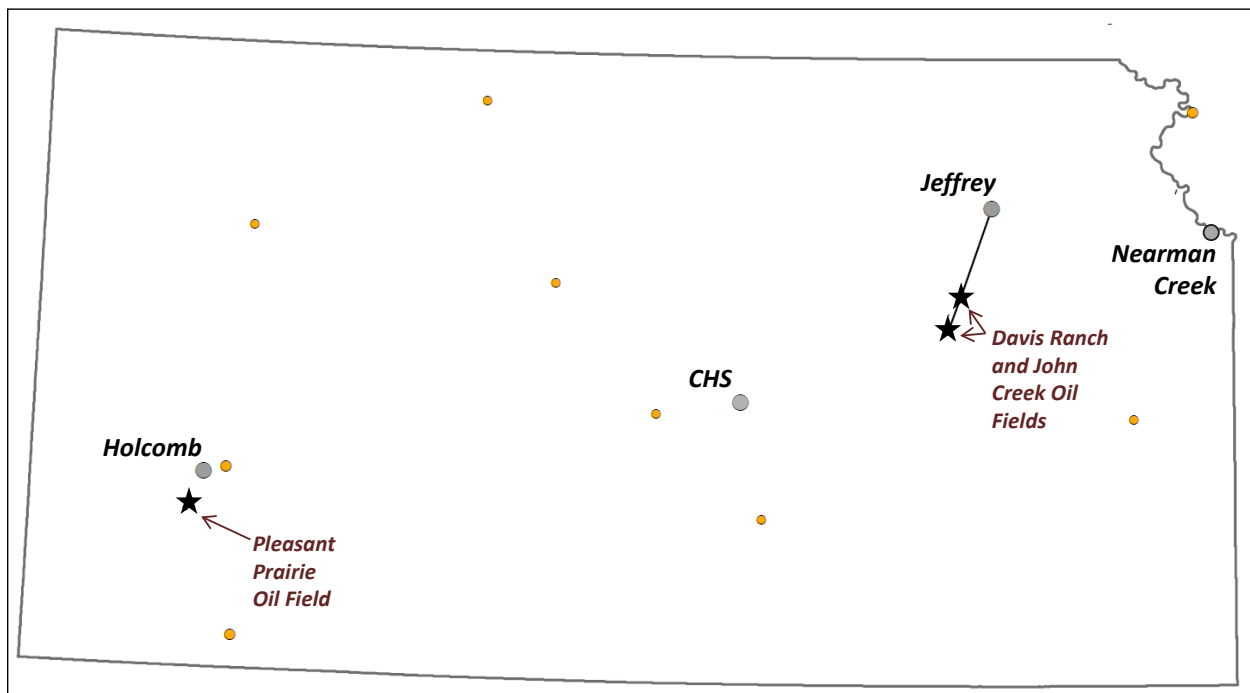

**Figure 2.** Pipeline Scenario 2, connecting Westar's Jeffrey Energy Center to Davis Ranch and John Creek oil fields. Potential CO<sub>2</sub> sources include ICKan industry partners (gray circles) and ethanol plants (yellow circles). Possible saline aquifer storage sites are beneath oil fields.



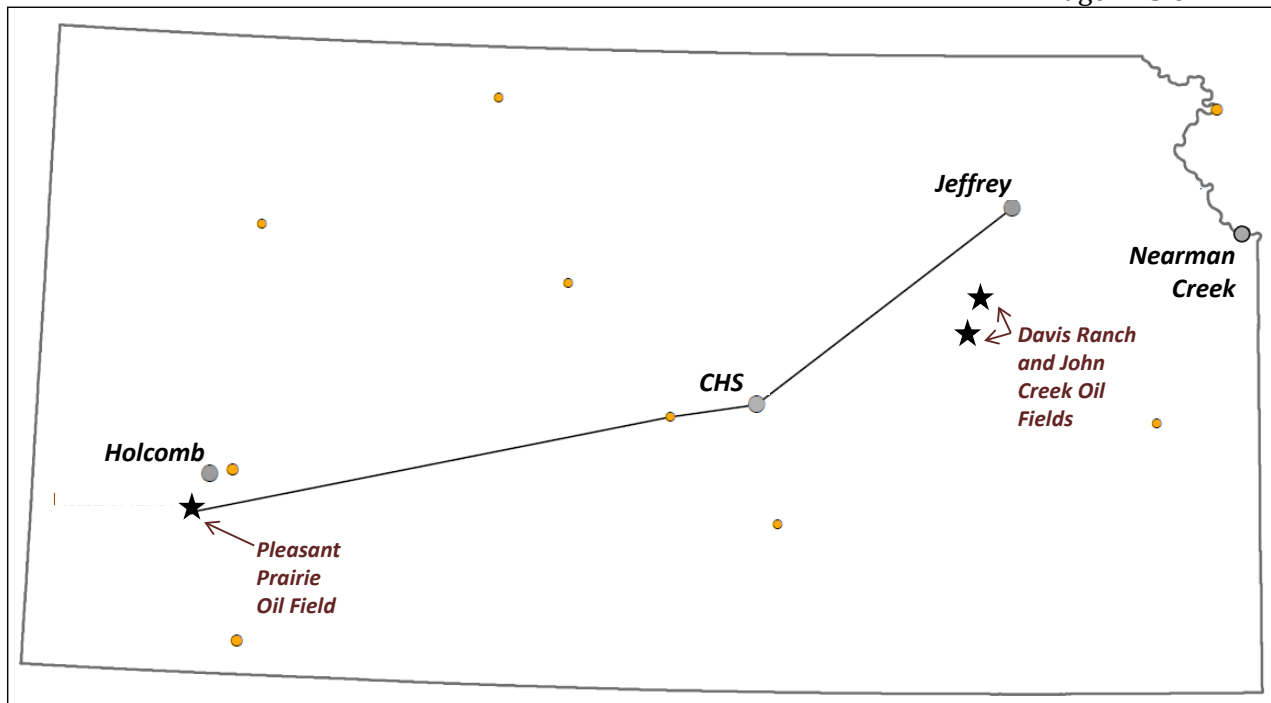

**Figure 3.** Pipeline Scenarios 3 and 4. Scenario 3 connects Westar’s Jeffrey Energy Center the CHS Refinery and then to the Pleasant Prairie oil field. Potential CO2 sources include ICKan industry partners (gray circles) and ethanol plants (yellow circles). Possible saline aquifer storage sites are beneath oil fields.

Number of Segments	32	
Distance X 1.2 (mi)	1,867	
CO2 Volume (Mtonnes/yr)	13.44	
Pipeline sizes (in)	4" to 24"	
Booster Station Count	75	
NETL Model CapX (\$M)	\$2,254	
NETL Model OpX/yr (\$M)	\$76.5	
*Additional Pump Station Count	32	
*Additional Pump CapX (\$M)	\$46	
*Additional Pump OpX (\$M/yr)	\$23.3	* NETL cost model does not account for additional pump stations where segments join. Costs are estimated.
Total Capital Costs (\$M)	\$2,300	
Total Operating Costs (\$M/yr)	\$99.8	

**Table 5.** Scenario 1 gathering and transportation system summary statistics, and capital and operating costs.

	Scenario No.	Distance (mi)	Distance (mi) X 1.2	Volume (MT/yr)	Size (inches)	CapX (\$Million)	Annual OpX (\$Million)
Jeffrey EC to MidCon Trunk	part of 1	151	181	2.5	12"	\$164	\$3.8
Jeffrey EC to Davis Ranch and John Creek	2	42	51	2.5*	12" & 8"	\$47	\$1.3
Jeffrey EC to CHS and Pleasant Prairie	3	294	353	3.25**	12"	\$323	\$8.0
Jeffrey EC to Pleasant Prairie	4	294	353	2.5	12"	\$322	\$7.2

**Table 6.** Scenarios 2, 3, and 4 gathering and transportation system summary statistics, and capital and operating costs. Jeffery to main trunk line segment is also included.

### Discussion

The purpose of this investigation was to determine if the FE/NETL CO<sub>2</sub> Transport Cost Model could be modified to enable it to be a useful tool to efficiently calculate detailed cost estimates for complicated pipeline scenarios. The work presented here demonstrates that the tool is stable with the modifications made and provides ICKan with a means to quickly evaluate a variety of complex pipeline scenarios.

Although economic analysis was not part of the of this investigation, capital and operating costs, excluding interest and business margin, are easily calculated relative to the volume of CO<sub>2</sub> delivered. For Scenario 1, the large-scale example: assuming a 20-year operating life the model projects capital costs of \$8.56/tonne (\$0.45/mcf), operating costs of \$7.43/tonne (\$0.39/mcf), and total costs of (\$15.98/tonne (\$0.84/mcf).

### References

Dubois, M. K., S. W. White, and T. R. Carr, Co-generation, 2002, Ethanol Production and CO<sub>2</sub> Enhanced Oil Recovery: a Model for Environmentally and Economically Sound Linked Energy Systems: Proceedings 2002 AAPG Annual Meeting, Houston, Texas, p. A46. Kansas Geological Survey Open-file Report 2002-6. <http://www.kgs.ku.edu/PRS/Poster/2002/2002-6/index.html> Accessed 7/1/2017.

Grant, T., D. Morgan, and K. Gerdes, 2013, Carbon Dioxide Transport and Storage Costs in NETL Studies: Quality Guidelines for Energy Systems Studies: DOE/NETL-2013/1614, 22 p.

Grant, T. and D. Morgan, 2014, FE/NETL CO<sub>2</sub> Transport Cost Model. National Energy Technology Laboratory. DOE/NETL-2014/1667. <https://www.netl.doe.gov/research/energy-analysis/analytical-tools-and-data/co2-transport>. Accessed 6/28/2017.

US Dept. of Energy, Energy Information Administration, 2017, Ethanol Plans (EIA-819M Monthly Oxygenate Report, March 27, 2017. [https://www.eia.gov/maps/layer\\_info-m.php](https://www.eia.gov/maps/layer_info-m.php) Accessed June 1, 2017.